

WEATHERTEX CONSTRUCTION DETAIL GUIDE

WEATHERGROOVE PANELS

DIRECT FIX

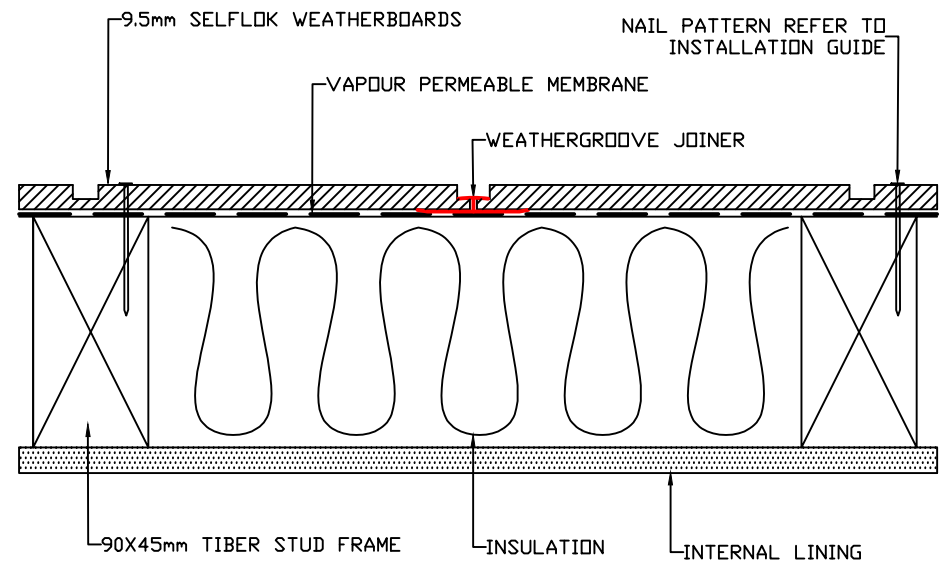



OFF STUD WEATHERGROOVE JOINER DETAIL

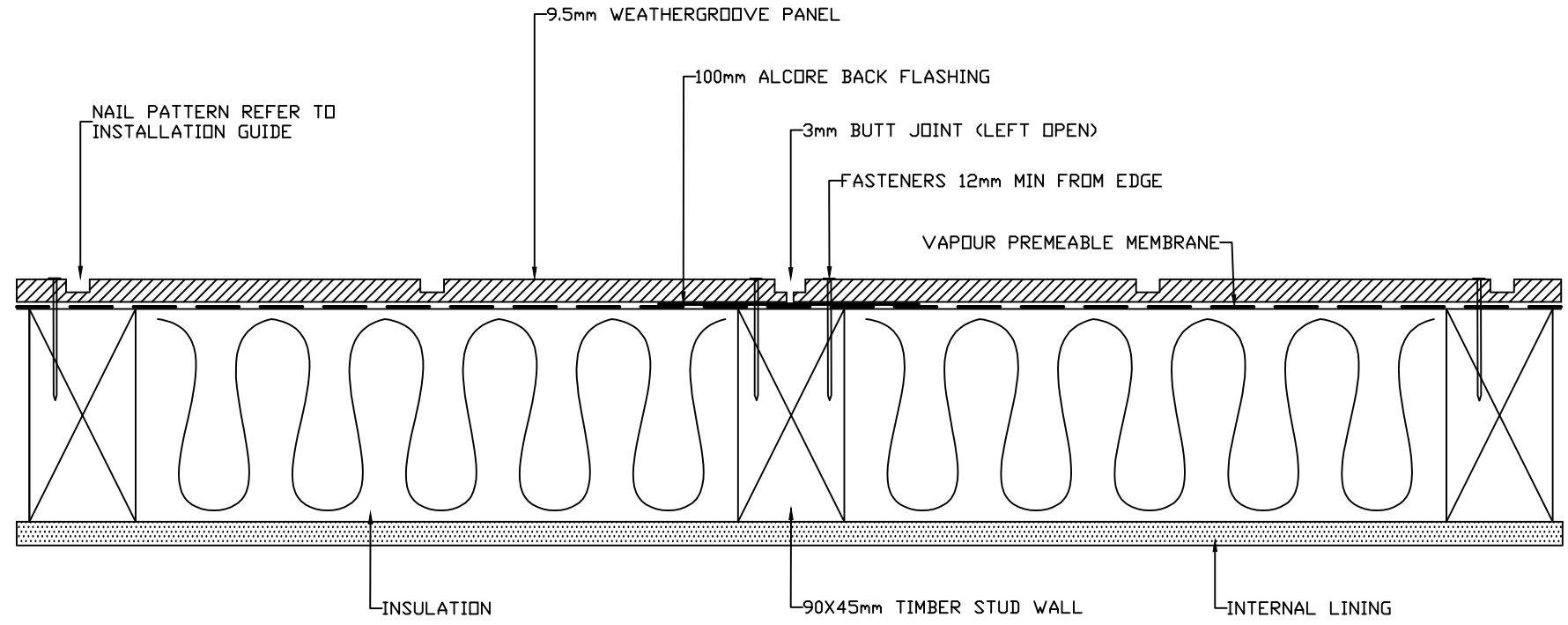

ON STUD BUTT JOIN DETAIL

	DRAWING NAME: DIRECT FIX INSTALLATION - WEATHERGROOVE	SCALE: NTS	DRAWN BY: A.MOATE	CHECKED BY: C.O'NEILL	DATE: 26.10.17	DRAWING SET No.: CD-WG-D	SHT SIZE A3
--	--	---------------	----------------------	--------------------------	-------------------	-----------------------------	----------------

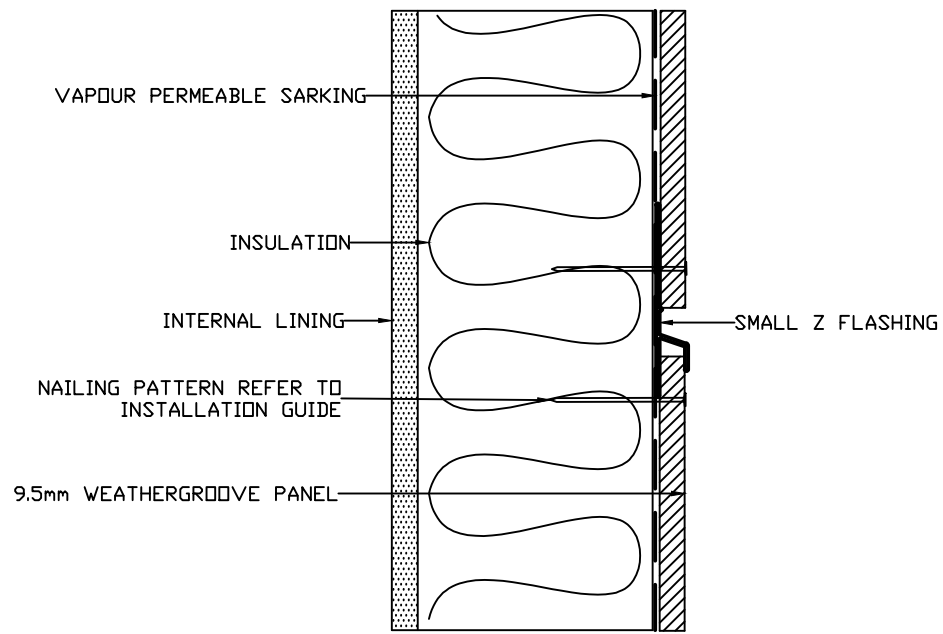

SMALL Z FLASHING JOIN DETAIL

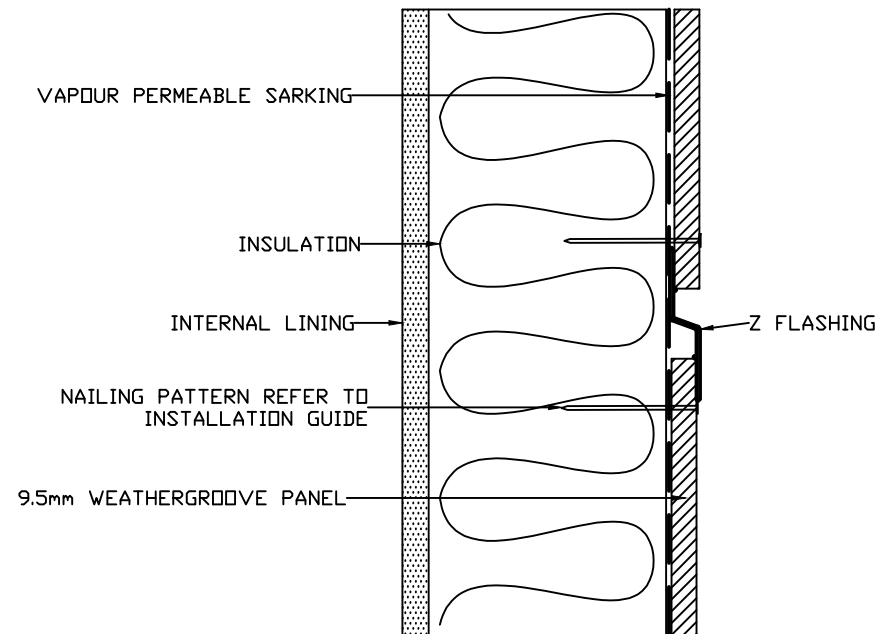

Z FLASHING JOIN DETAIL

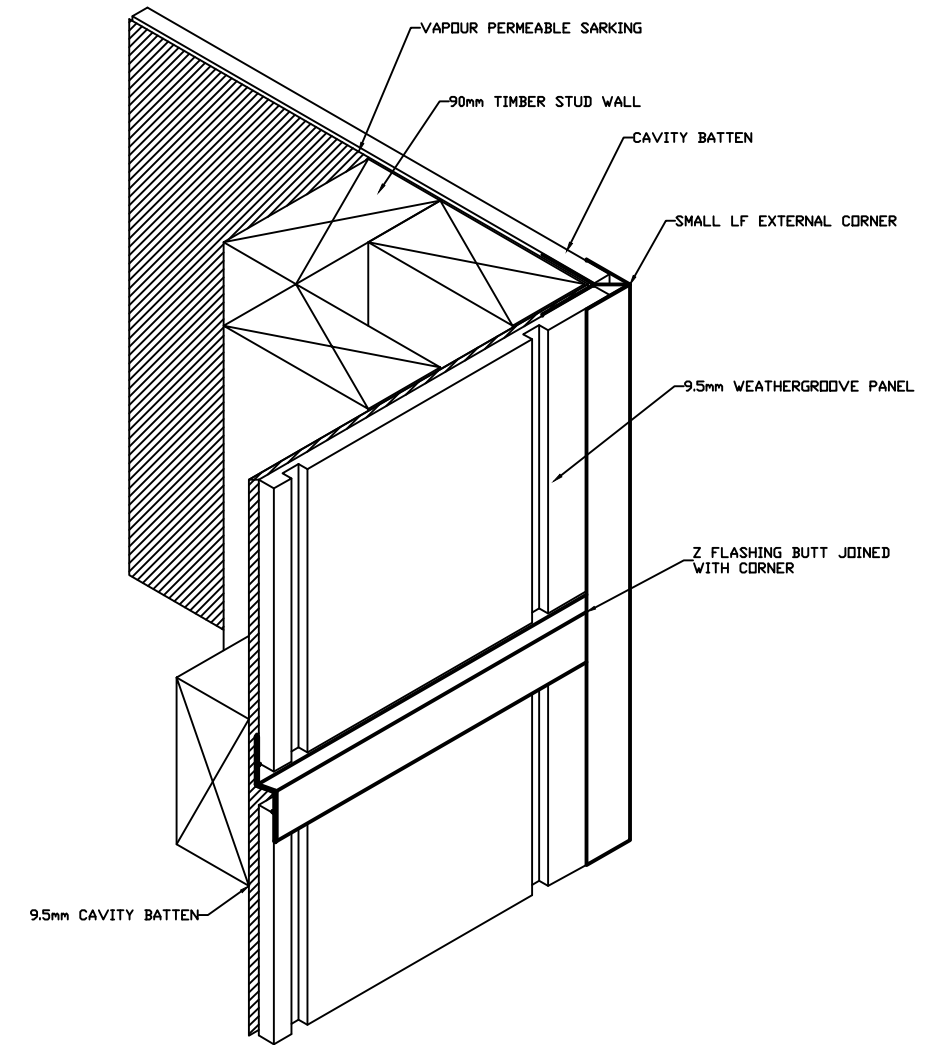

Z FLASHING INTO CORNER DETAIL



DRAWING NAME:
DIRECT FIX INSTALLATION - WEATHERGROOVE

SCALE:
NTS

DRAWN BY:
A.MOATE

CHECKED BY:
C.O'NEILL

DATE:
26.10.17

DRAWING SET No.:
CD-WG-D

SHT SIZE
A3

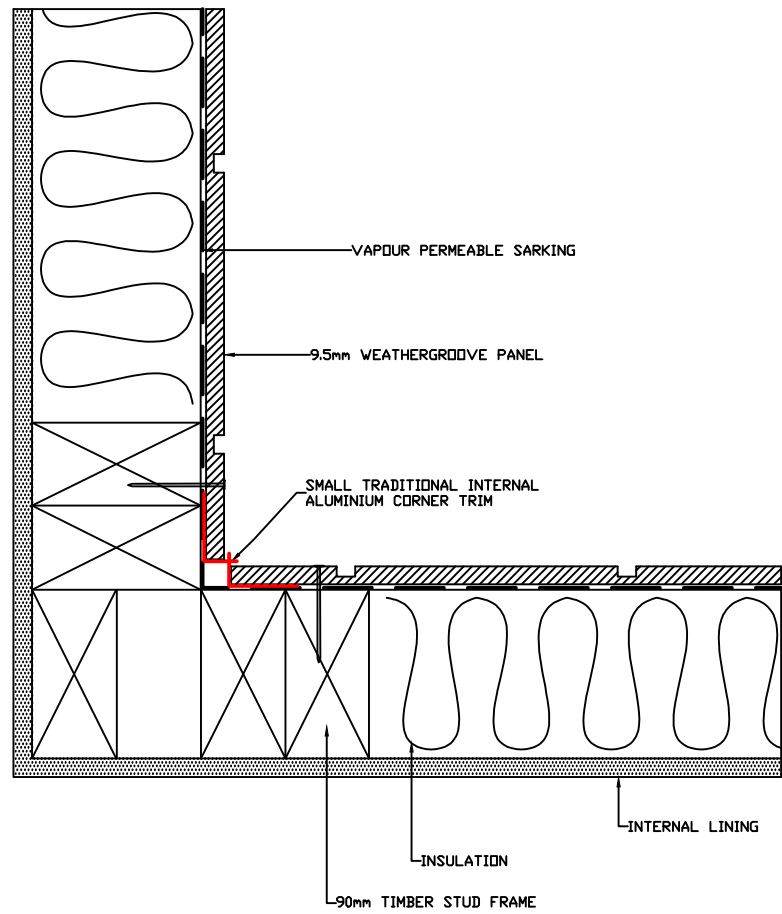

SMALL TRADITIONAL INTERNAL "W" CORNER DETAIL

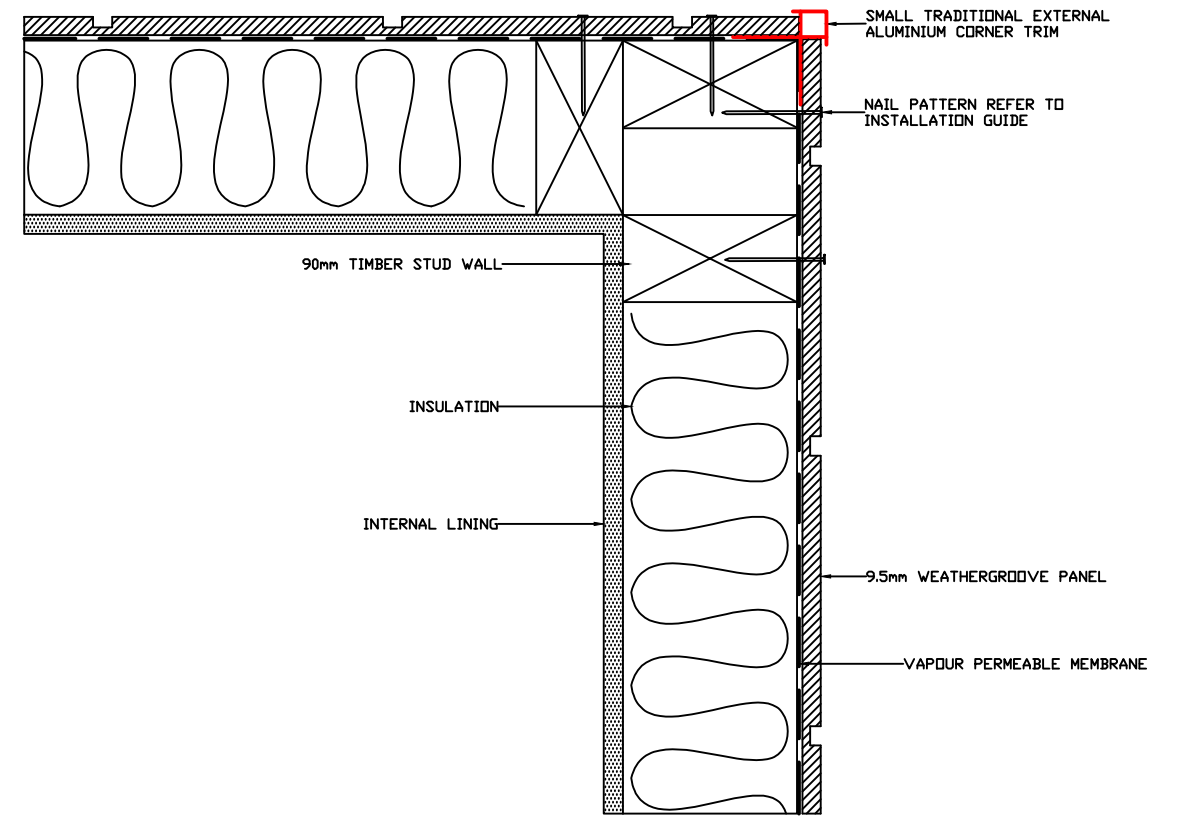

SMALL TRADITIONAL EXTERNAL "BOX" CORNER DETAIL

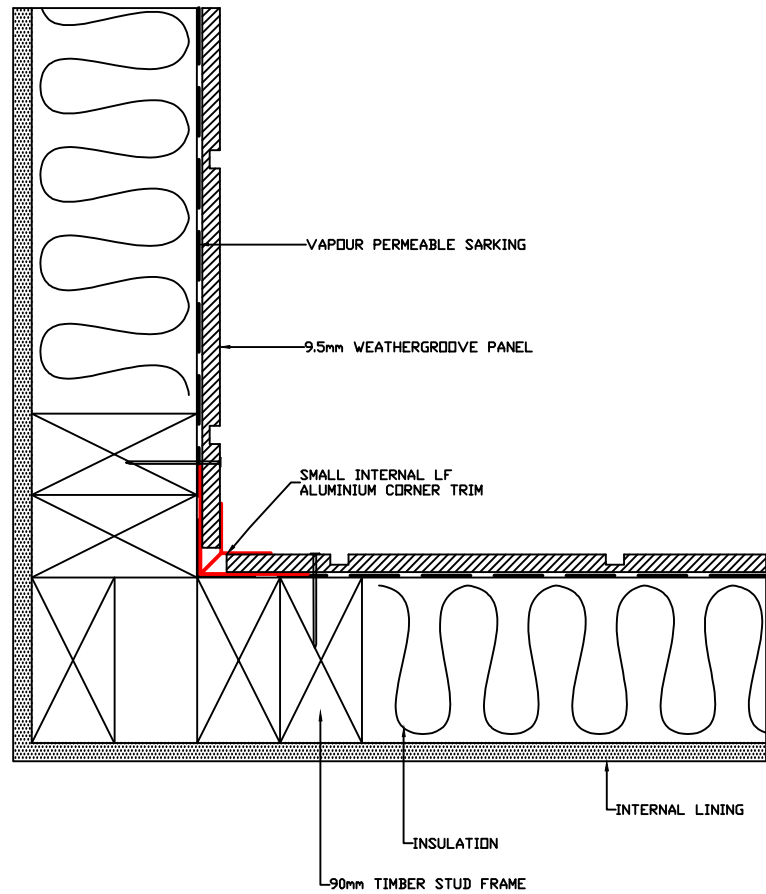

SMALL INTERNAL LF CORNER DETAIL

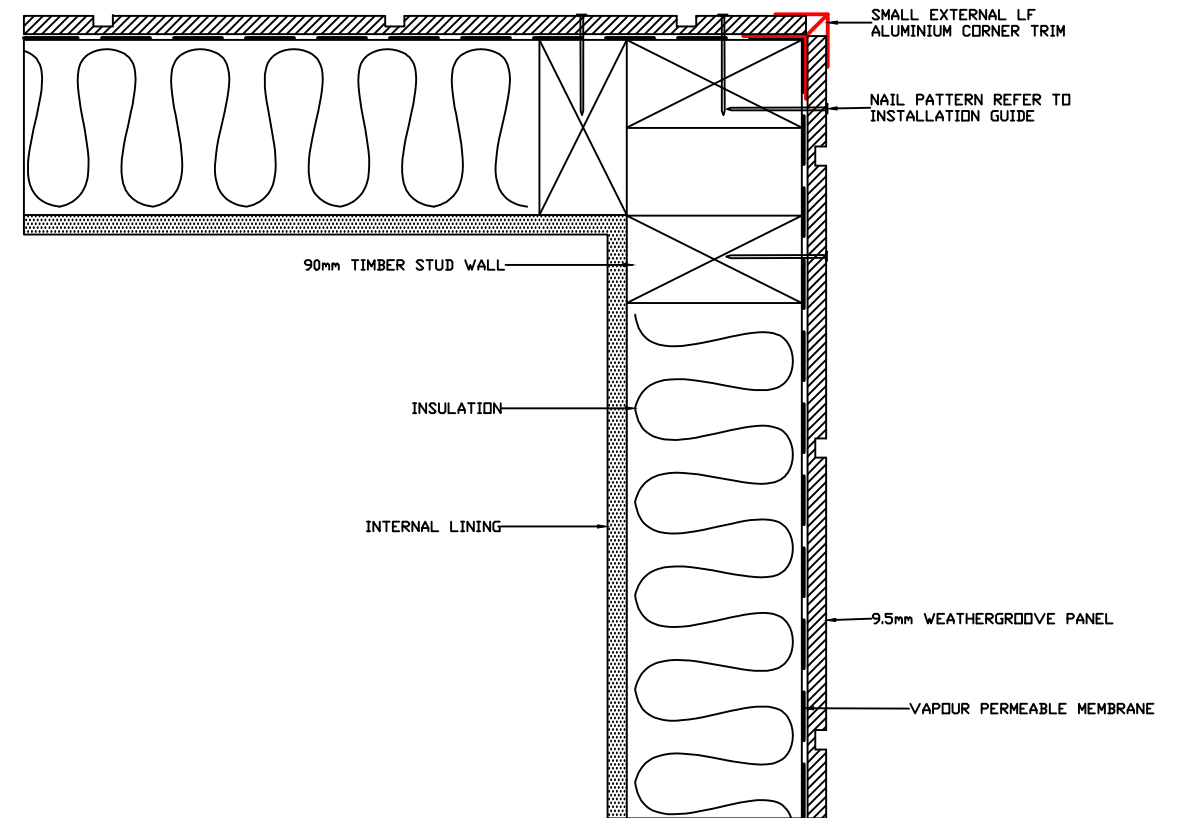

SMALL EXTERNAL LF CORNER DETAIL

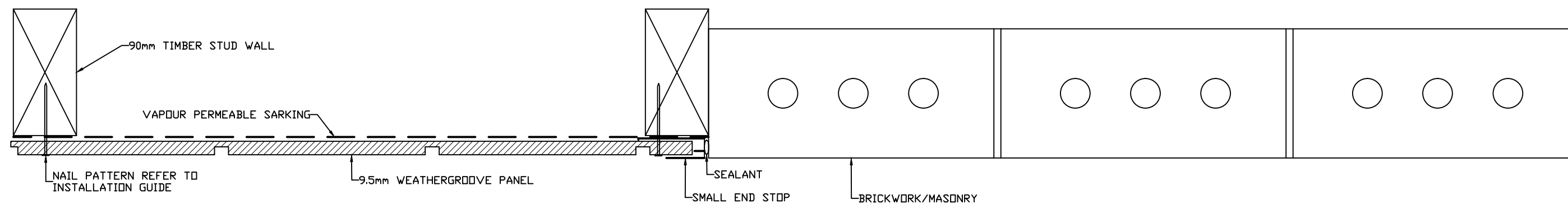

END STOP TO MASONRY BRICK DETAIL



DRAWING NAME:	SCALE:	DRAWN BY:	CHECKED BY:	DATE:	DRAWING SET No.:	SHT SIZE
DIRECT FIX INSTALLATION - WEATHERGROOVE	NTS	A.MOATE	C.O'NEILL	26.10.17	CD-WG-D	A3

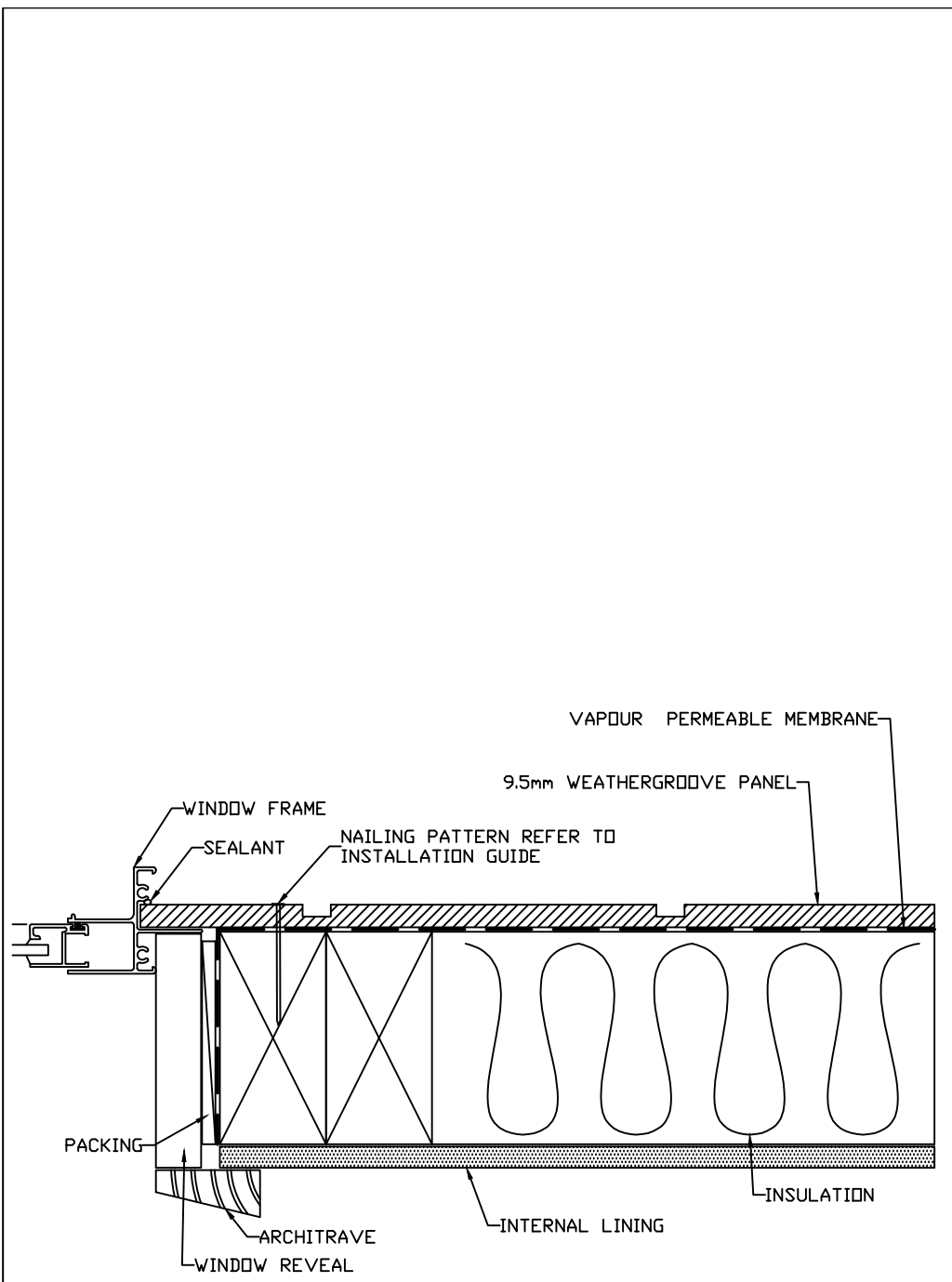

WINDOW JAMB DETAIL

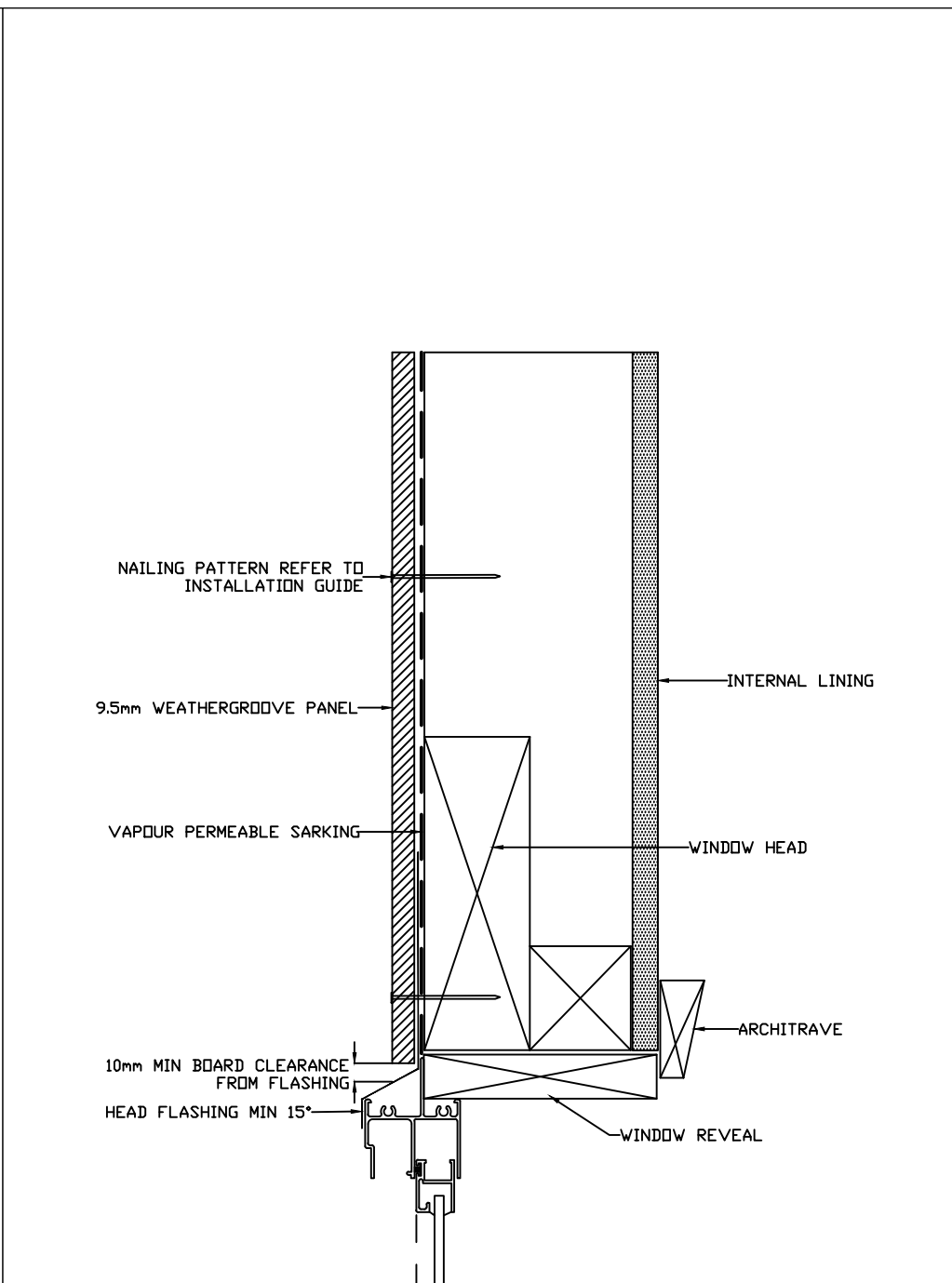

WINDOW HEAD DETAIL

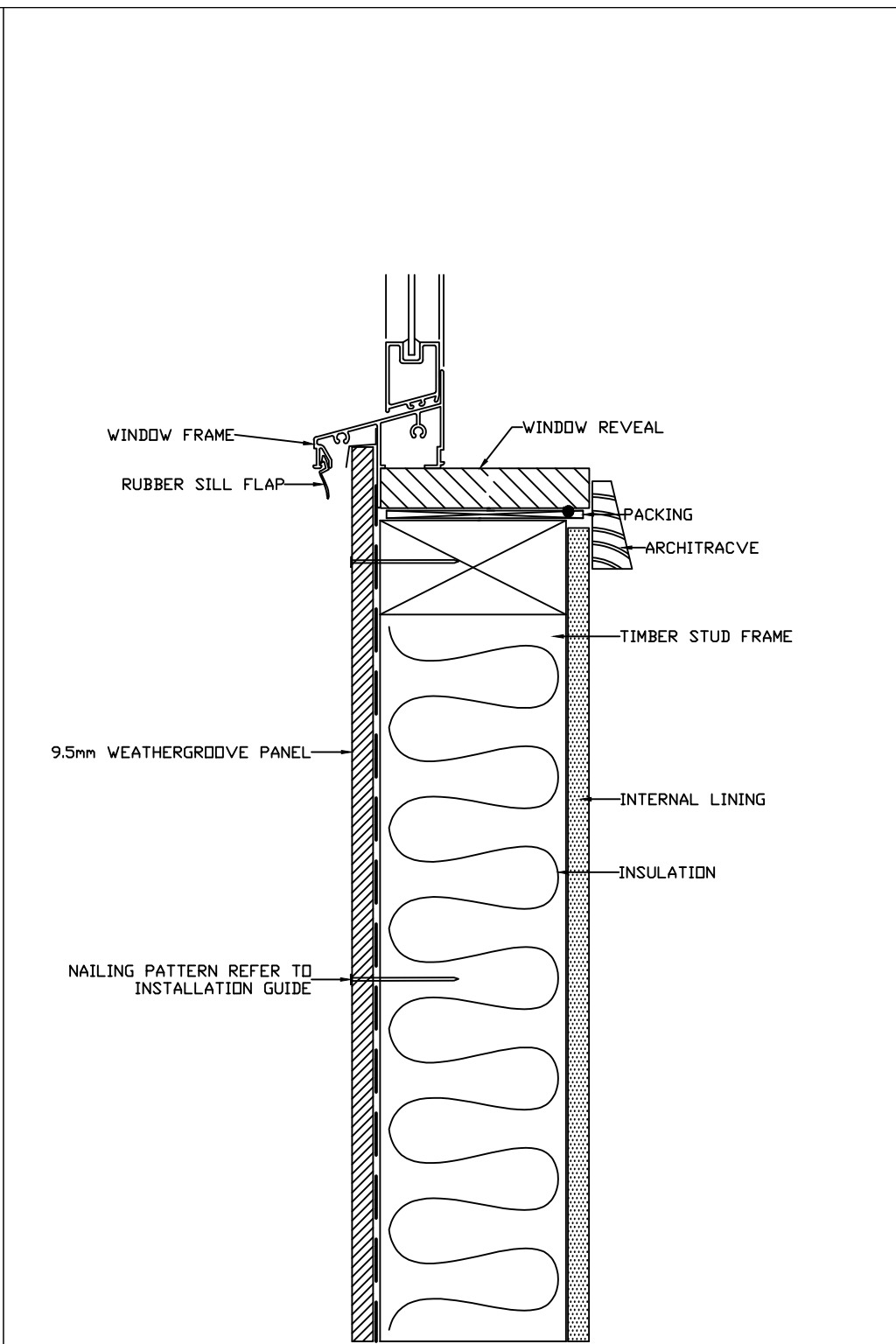

WINDOW SILL DETAIL

	DRAWING NAME: DIRECT FIX INSTALLATION - WEATHERGROOVE	SCALE: NTS	DRAWN BY: A.MOATE	CHECKED BY: C.O'NEILL	DATE: 27.11.17	DRAWING SET No.: CD-WG-D	SHT SIZE A3
--	---	----------------------	-----------------------------	---------------------------------	--------------------------	------------------------------------	-----------------------

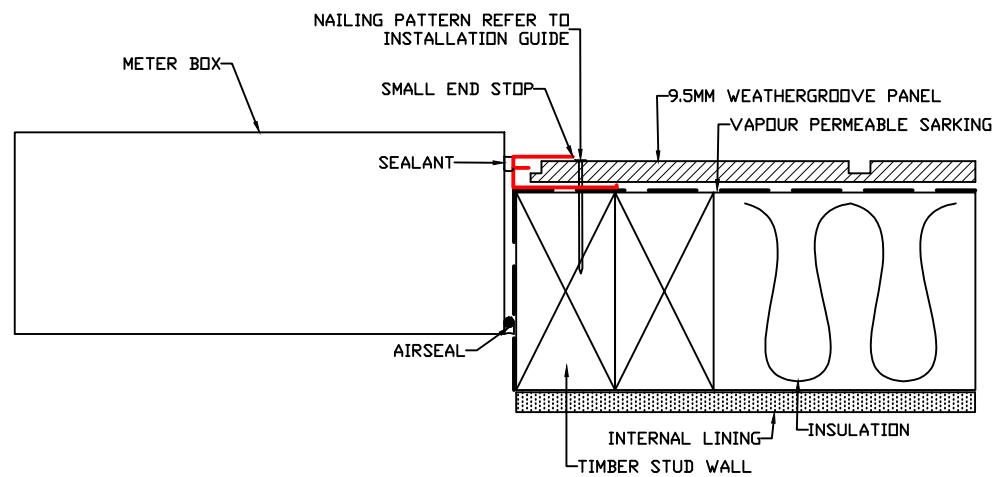

METER BOX JAMB
DETAIL

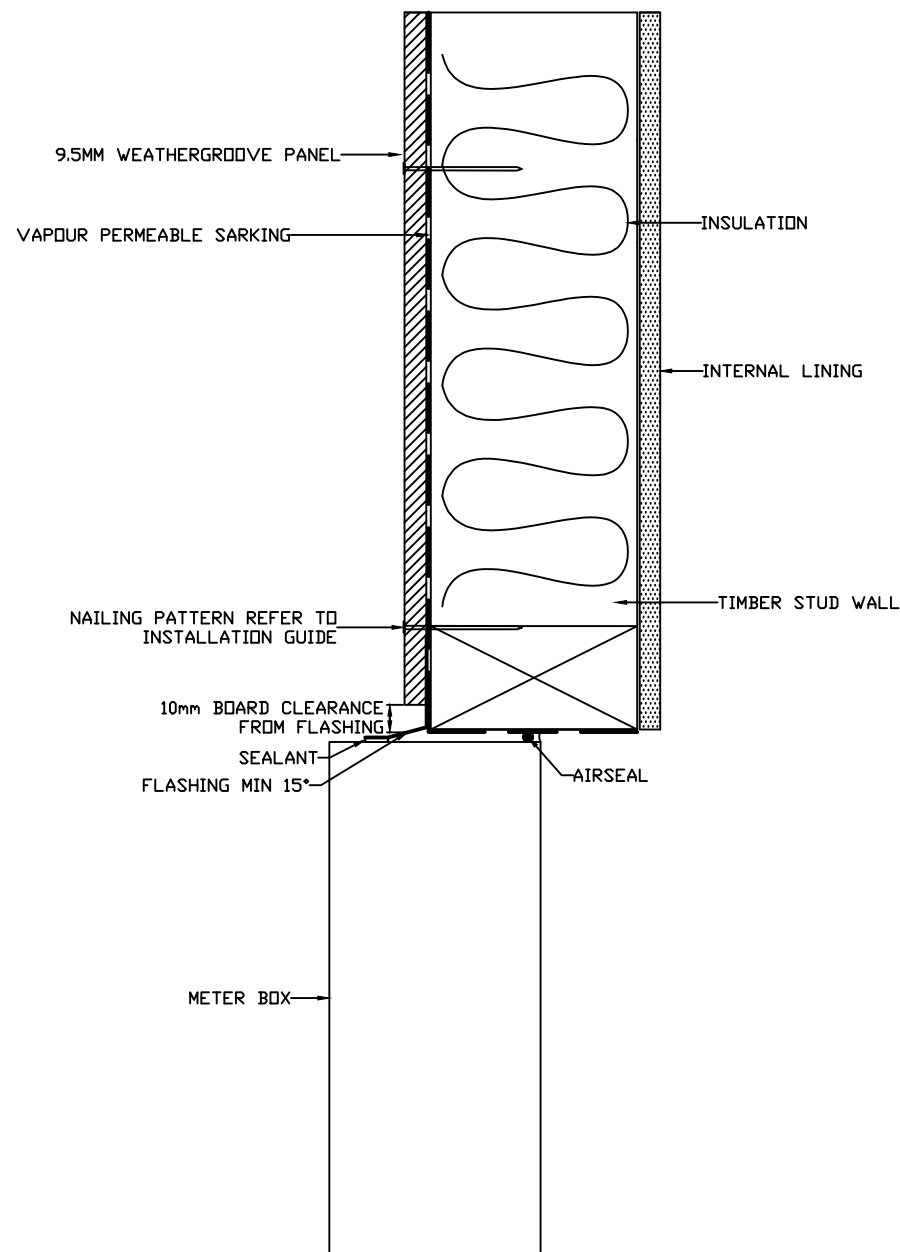

METER BOX HEAD
DETAIL

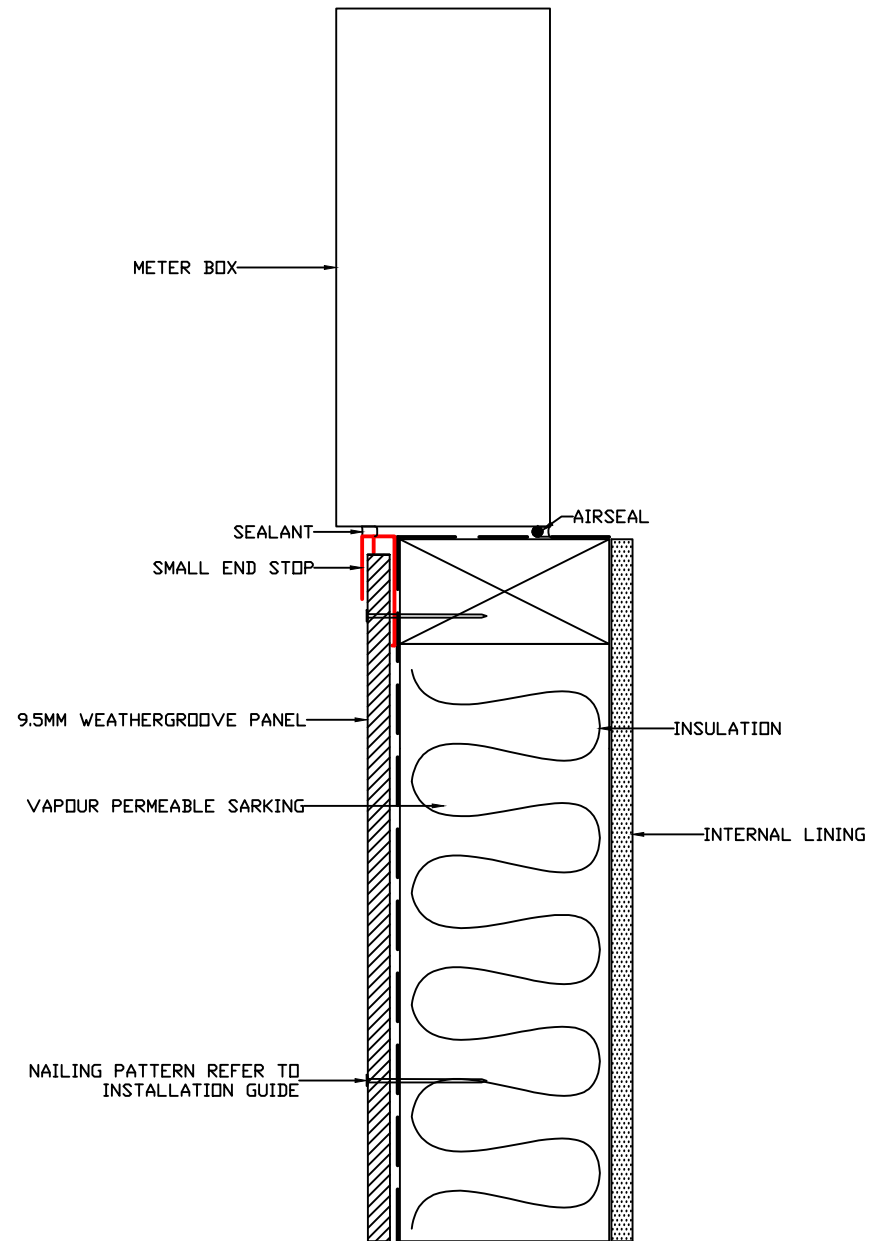

METER BOX SILL
DETAIL

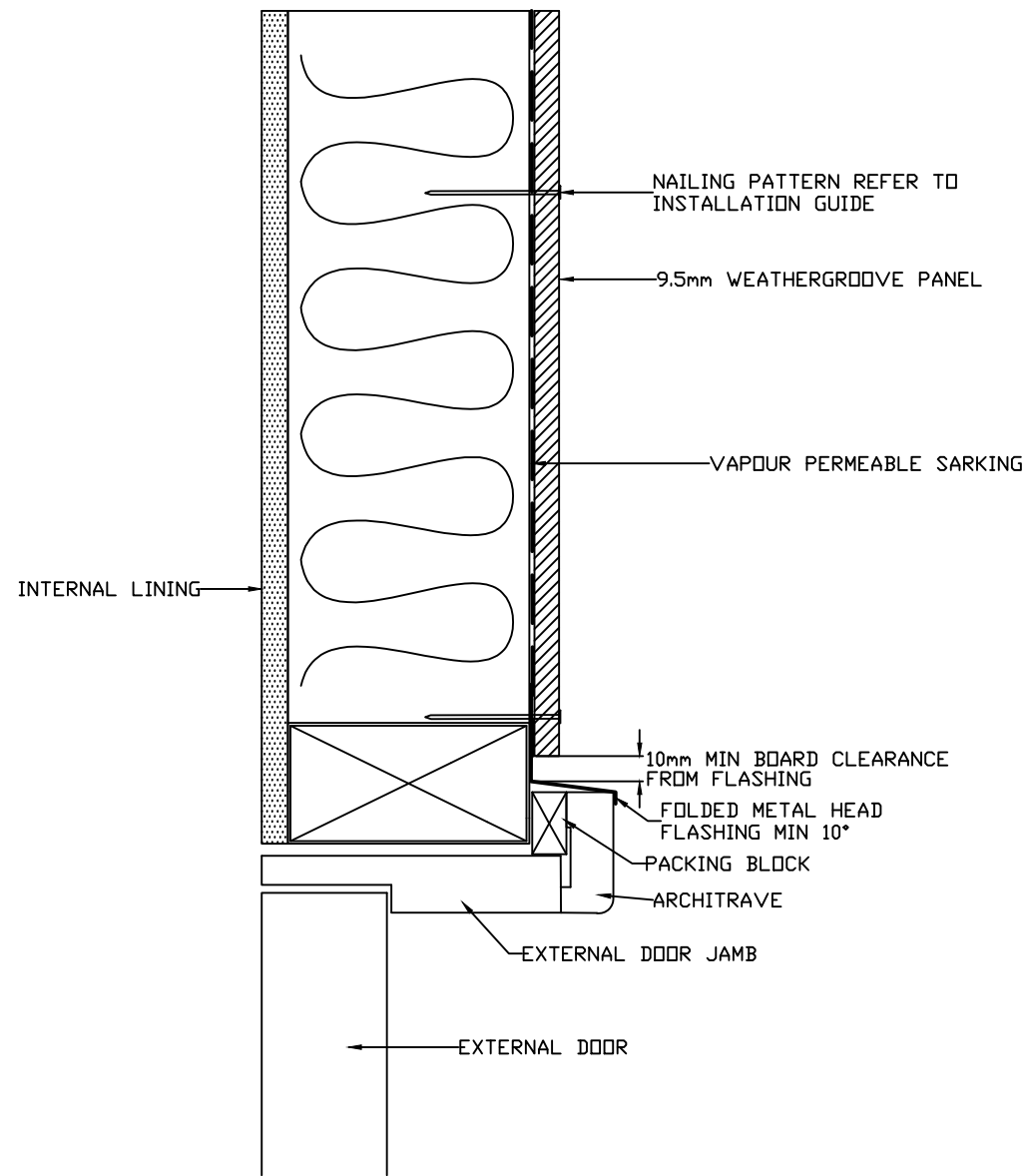

DOOR HEADER DETAIL

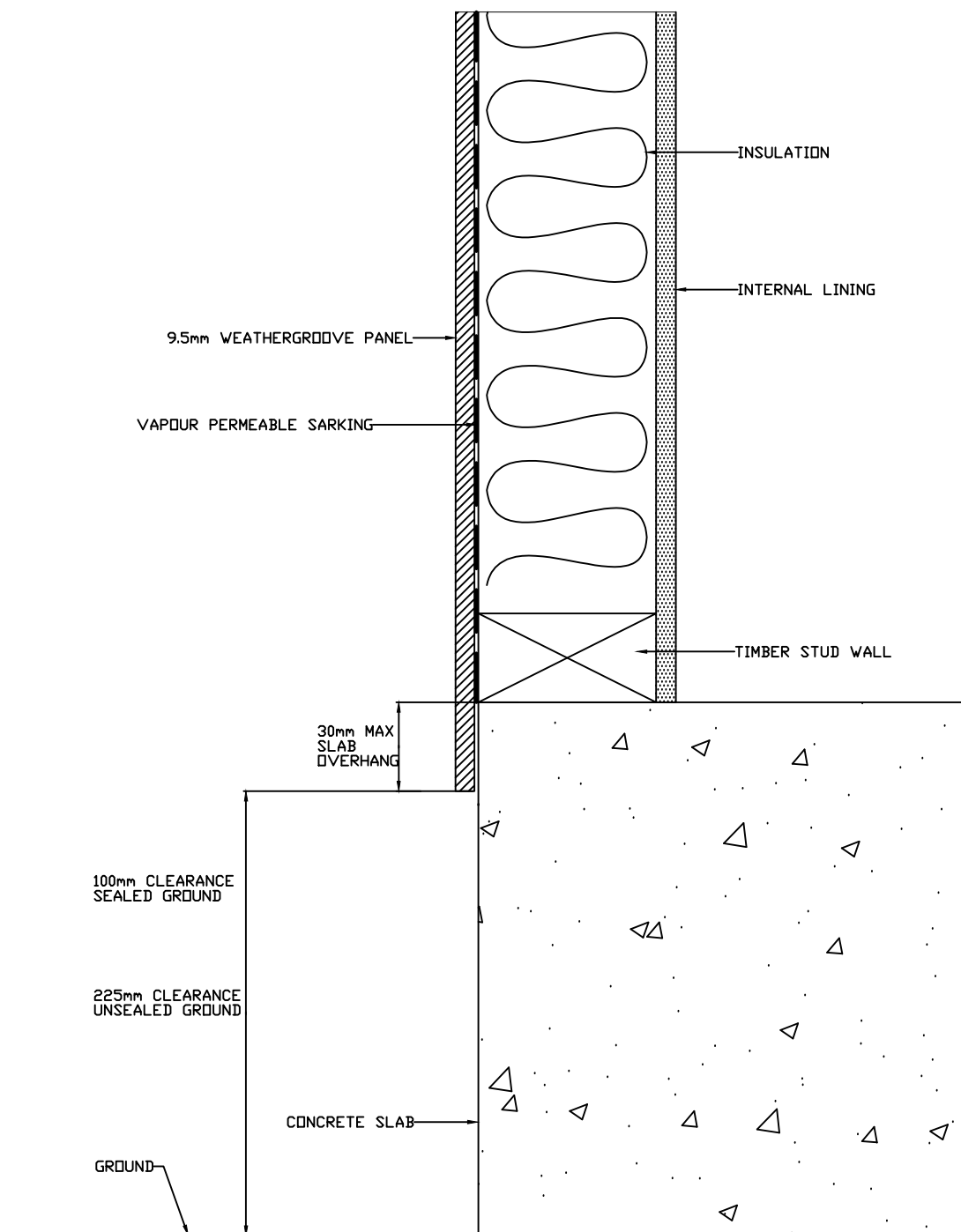

CONCRETE SLAB
GROUND CLEARANCE DETAIL

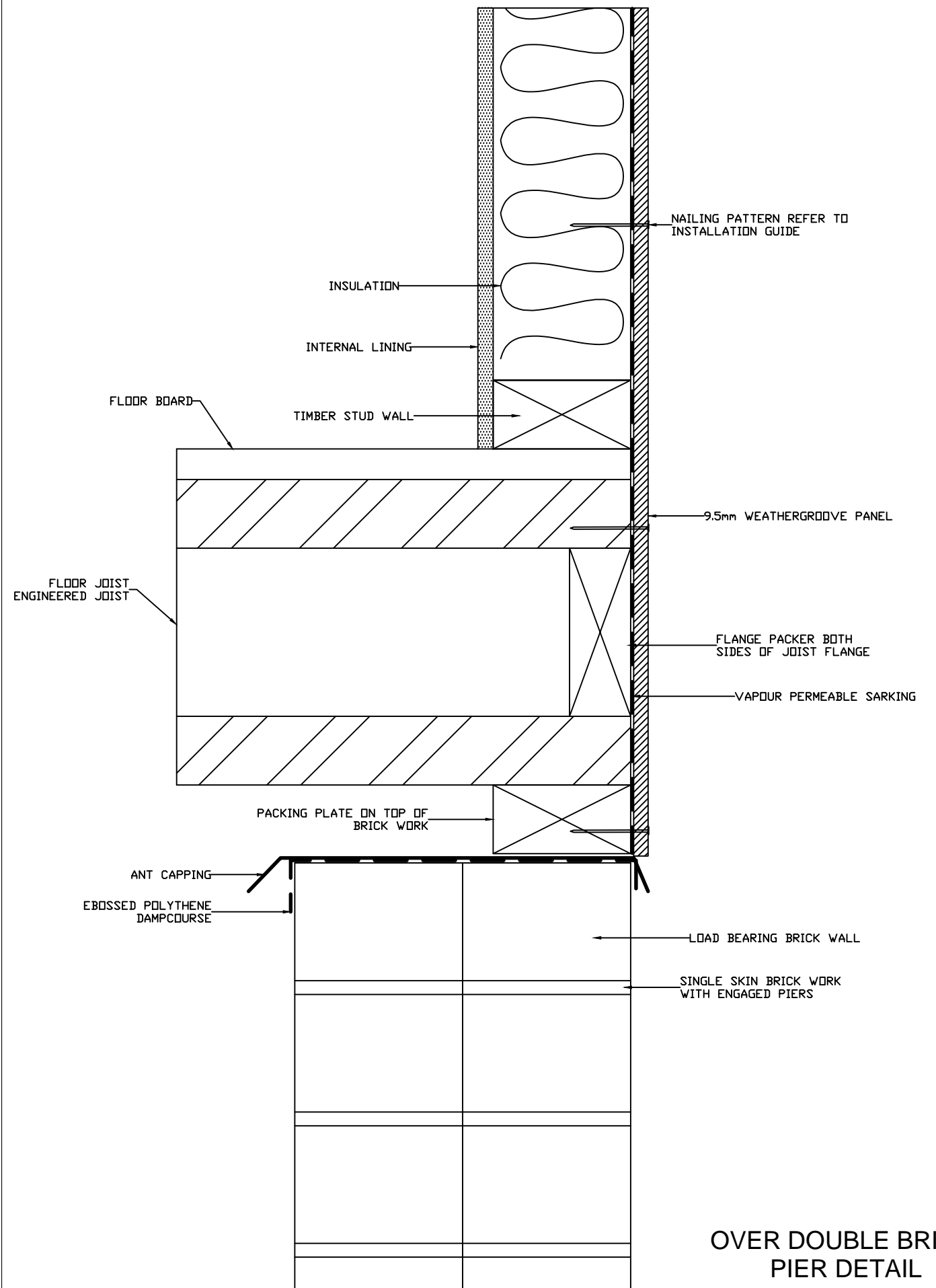

OVER DOUBLE BRICK
PIER DETAIL

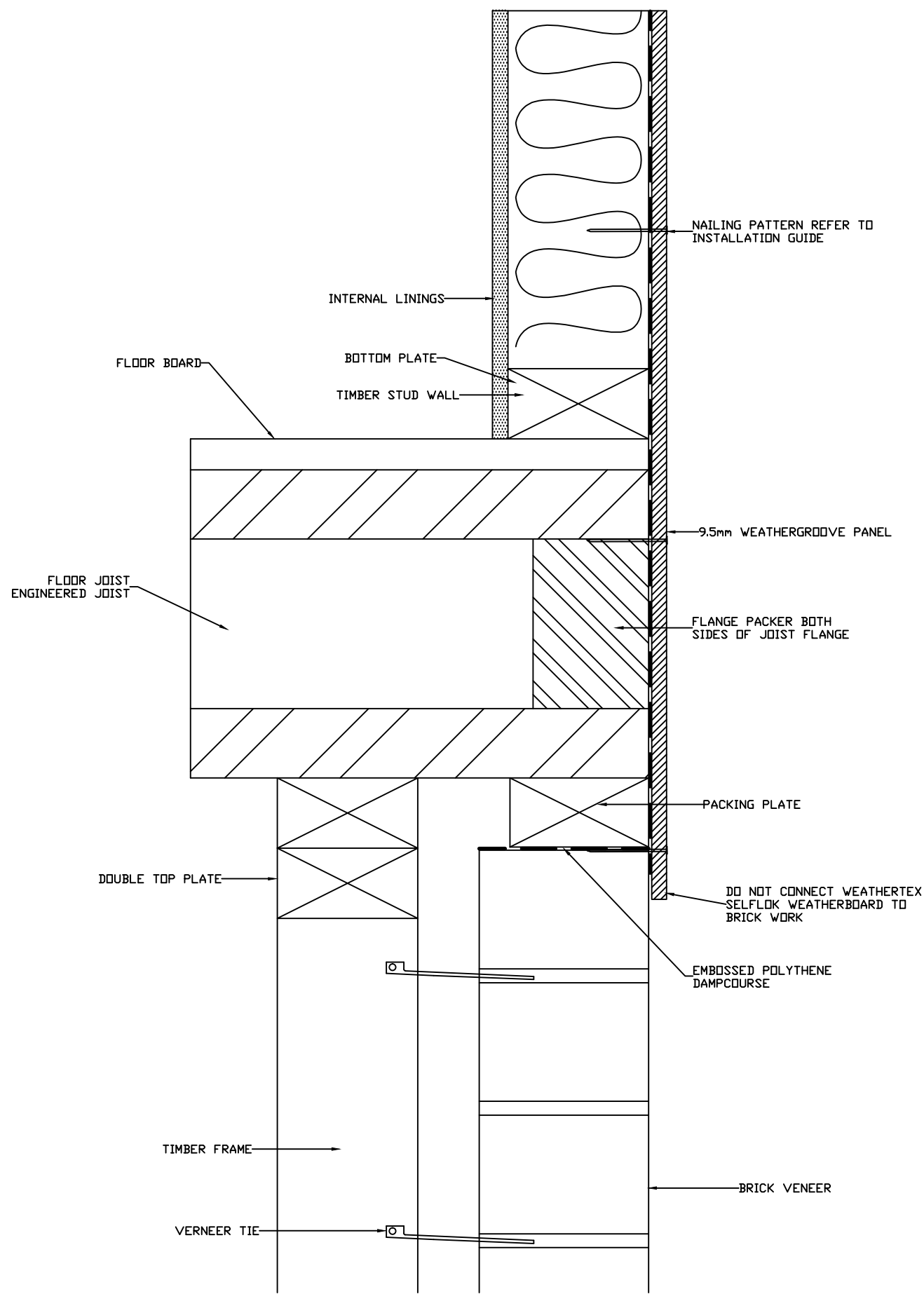

FLUSH WITH BRICK VENEER DETAIL

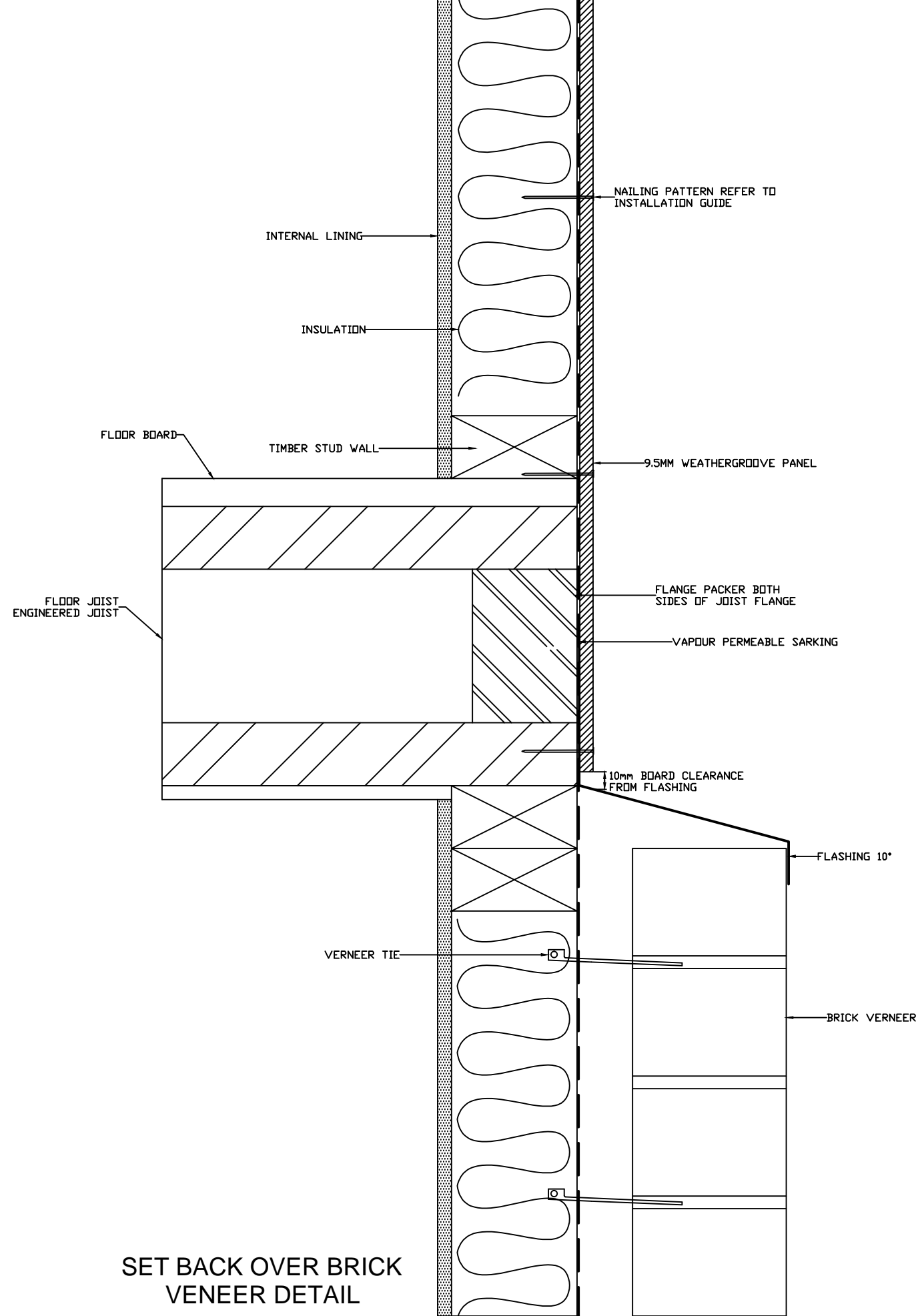

SET BACK OVER BRICK VENEER DETAIL



DRAWING NAME:
DIRECT FIX INSTALLATION - WEATHERGROOVE

SCALE:
NTS

DRAWN BY:
A.MOATE

CHECKED BY:
C.O'NEILL

DATE:
26.10.17

DRAWING SET No.:
CD-WG-D

SHT SIZE
A3

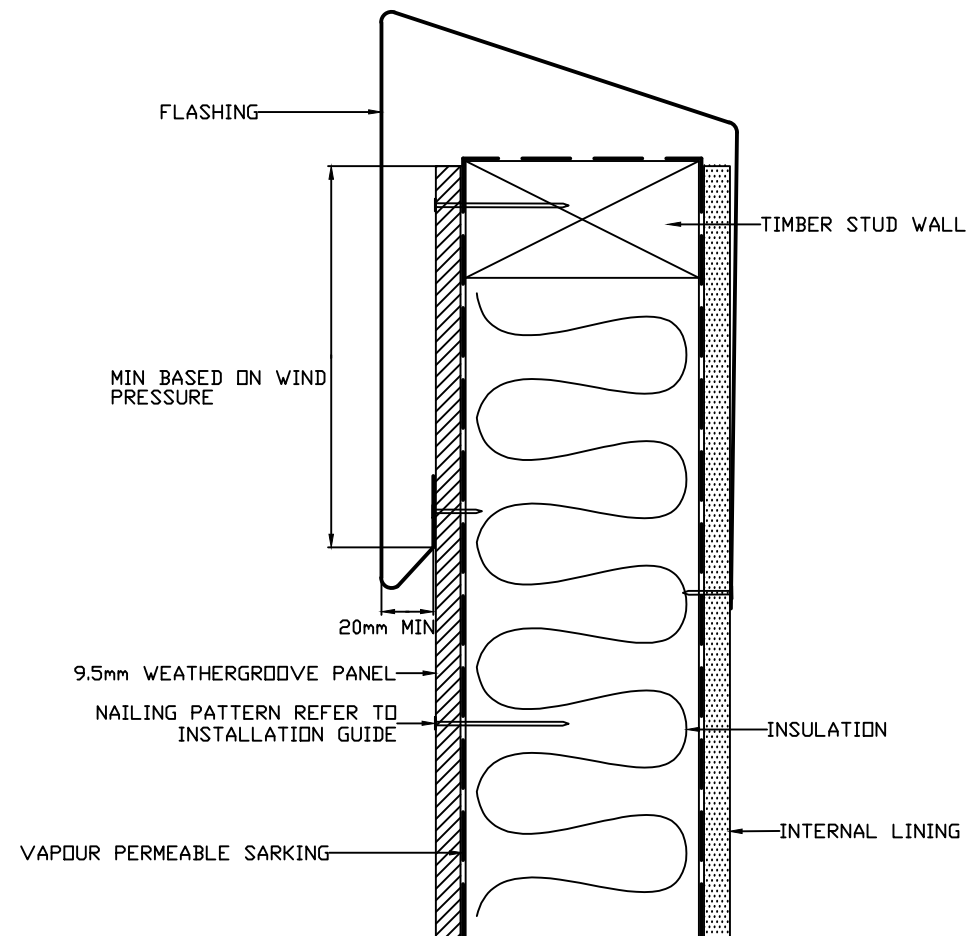

PARAPET DETAIL

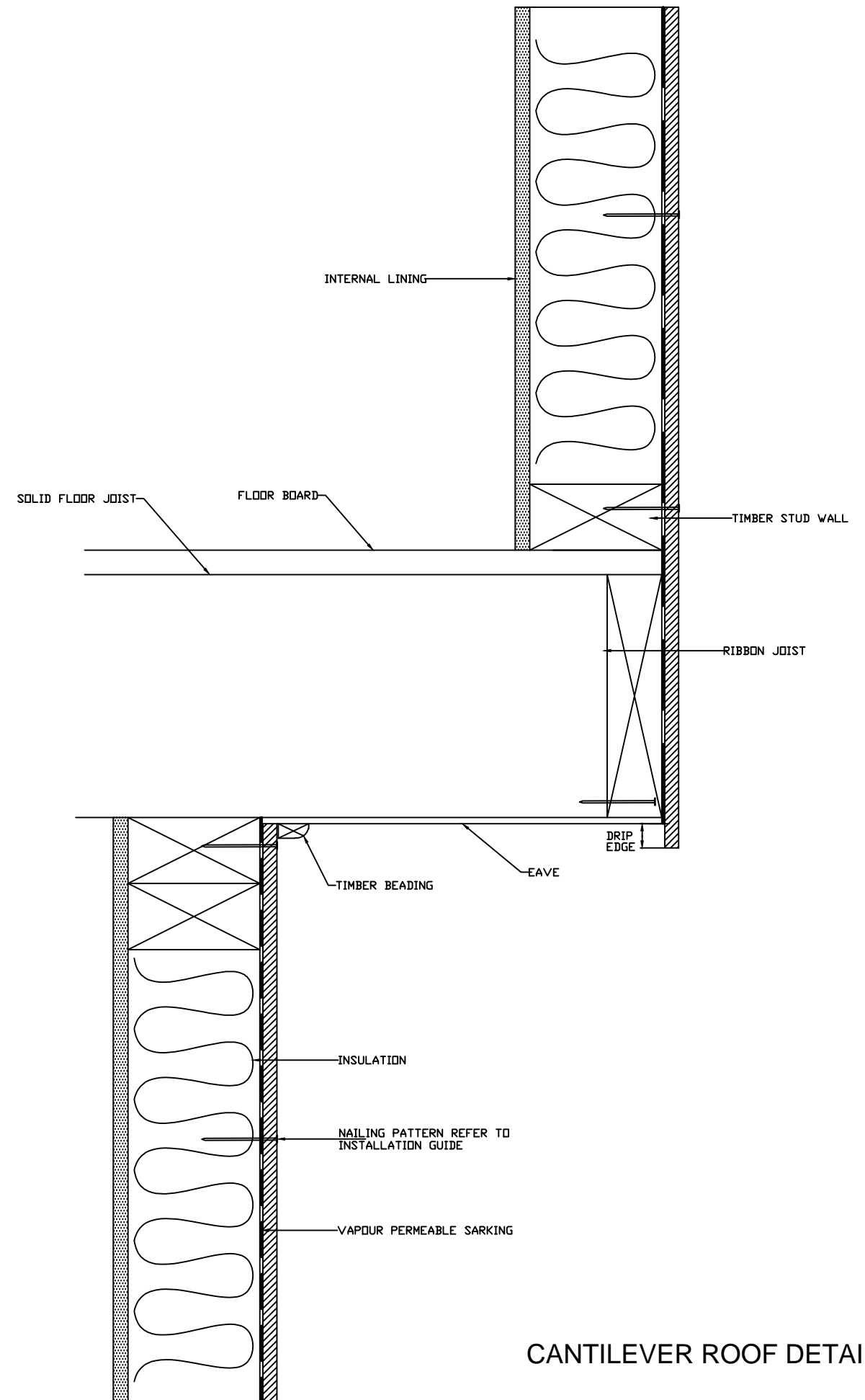

CANTILEVER ROOF DETAIL



DRAWING NAME:
DIRECT FIX INSTALLATION - WEATHERGROOVE

SCALE:
NTS

DRAWN BY:
A.MOATE

CHECKED BY:
C.O'NEILL

DATE:
26.10.17

DRAWING SET No.:
CD-WG-D

SHT SIZE
A3

ROOF CLEARANCE DETAIL

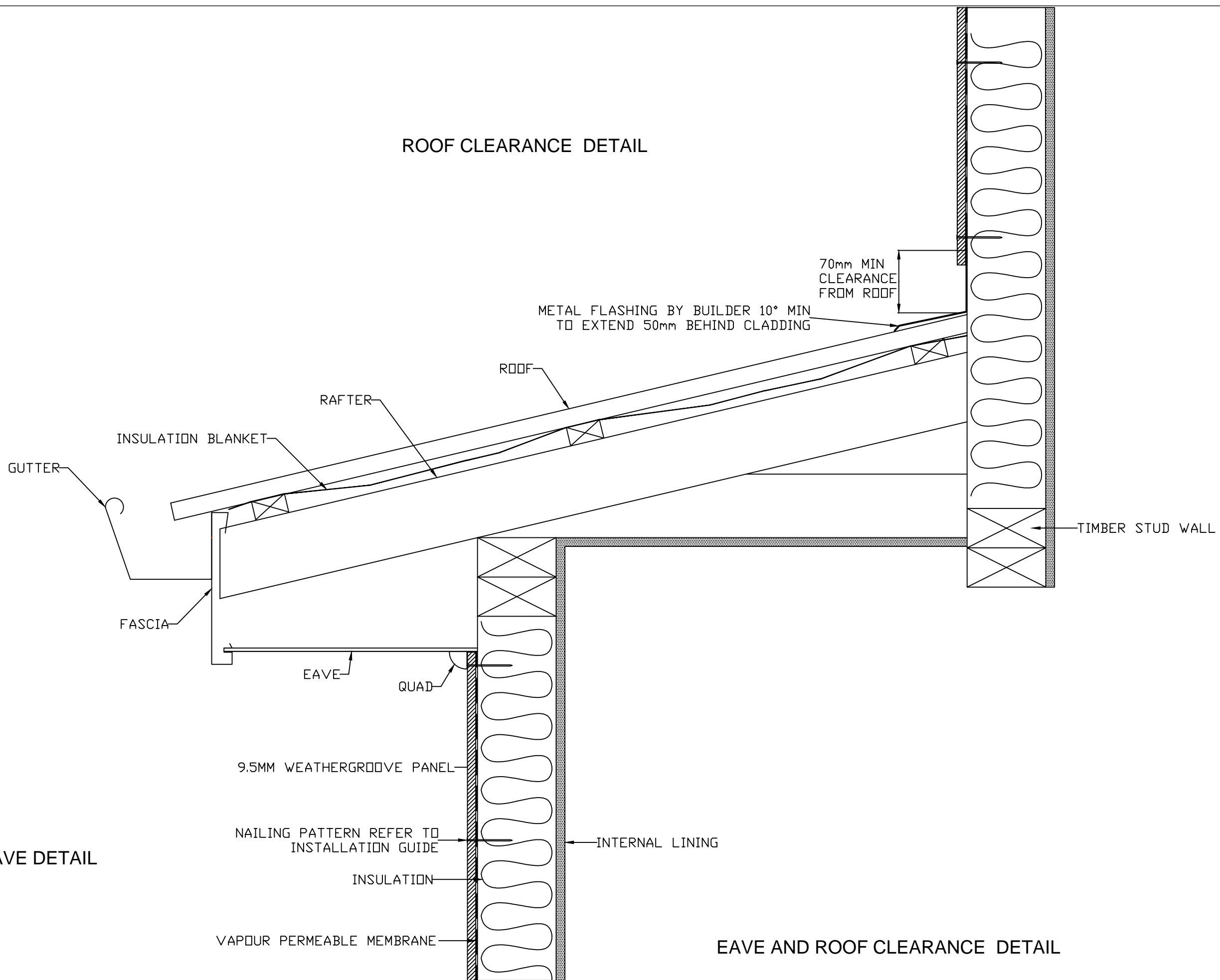

EAVE DETAIL

EAVE AND ROOF CLEARANCE DETAIL

	DRAWING NAME:	SCALE:	DRAWN BY:	CHECKED BY:	DATE:	DRAWING SET No.:	SHT SIZE
	DIRECT FIX INSTALLATION - WEATHERGROOVE	NTS	A.MOATE	C.O'NEILL	26.10.17	CD-WG-D	A3

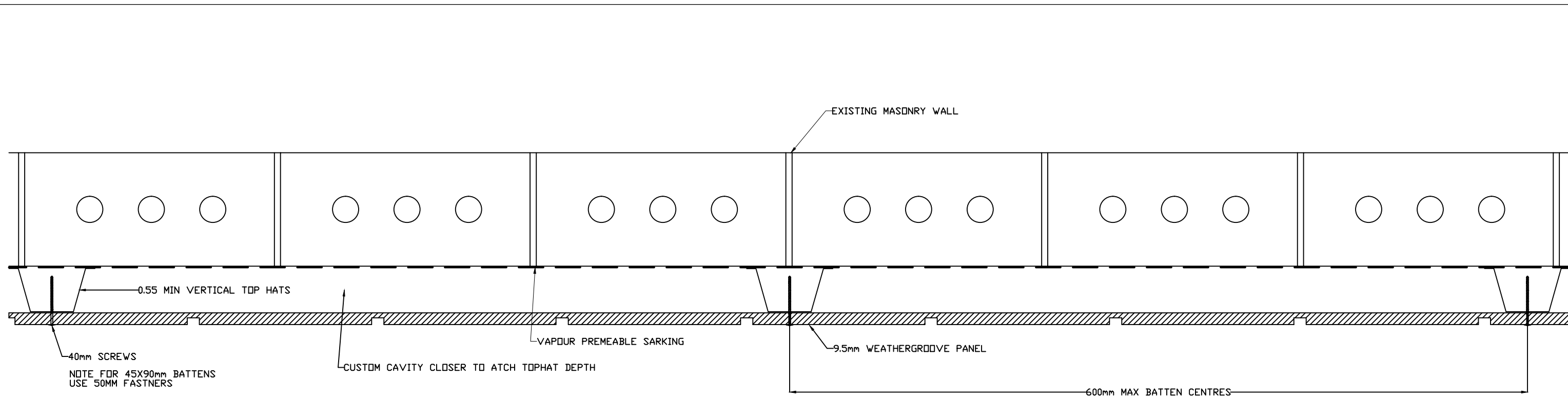

**CLADDING OVER MASONRY WITH
METAL TOPHATS DETAIL**

NOTE: VERTICAL BATTENS ONLY

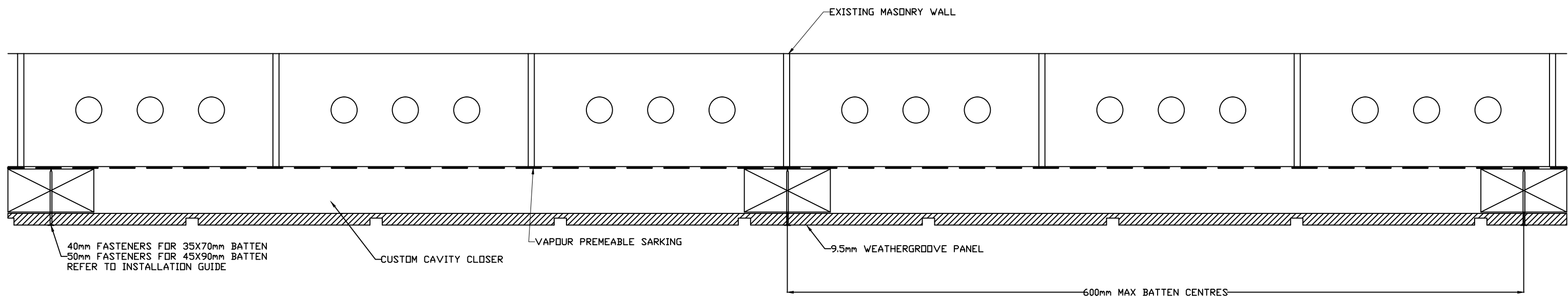

**CLADDING OVER BRICK WITH
TIMBER BATTEN DETAIL**

NOTE: VERTICAL BATTENS ONLY