

# WEATHERTEX CONSTRUCTION DETAIL GUIDE

## PRIMELOK WEATHERBOARDS

### DIRECT FIX

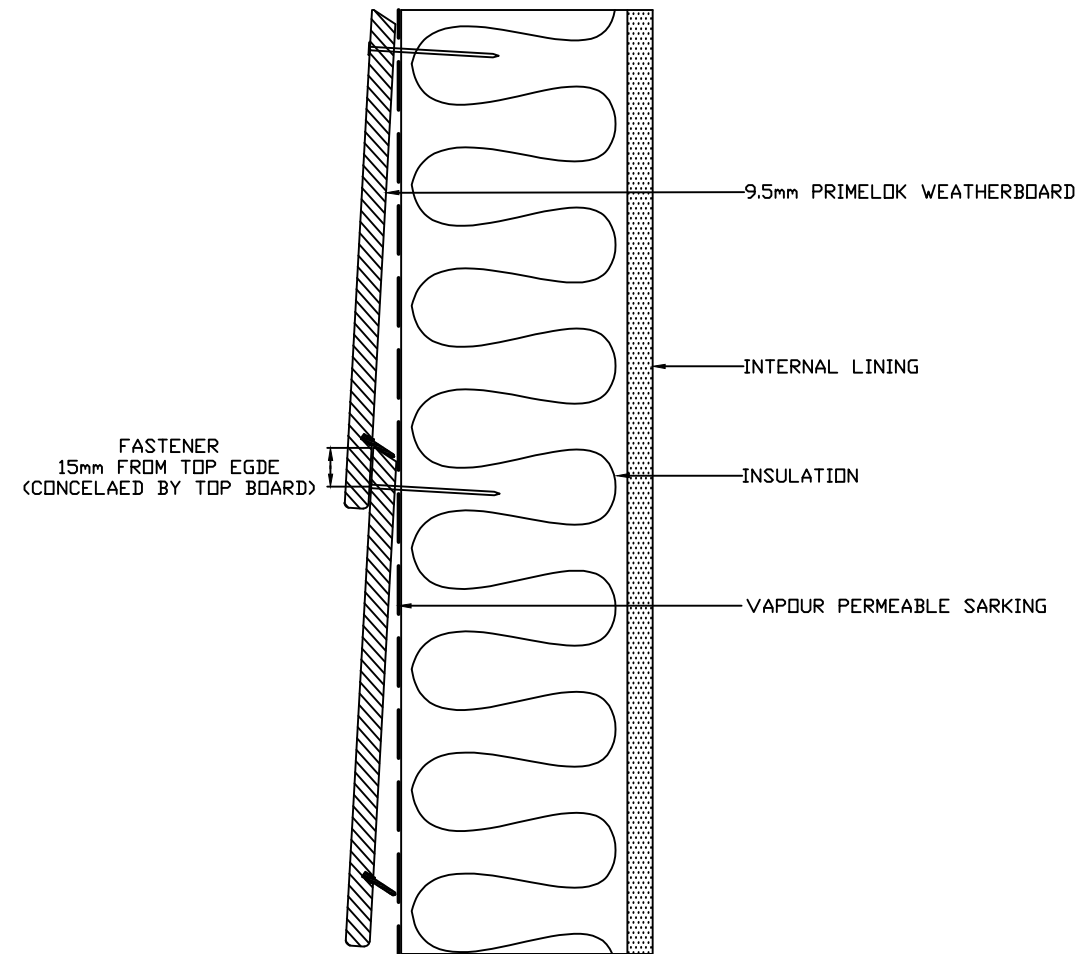



PRIMELOK FIXING  
DETAIL

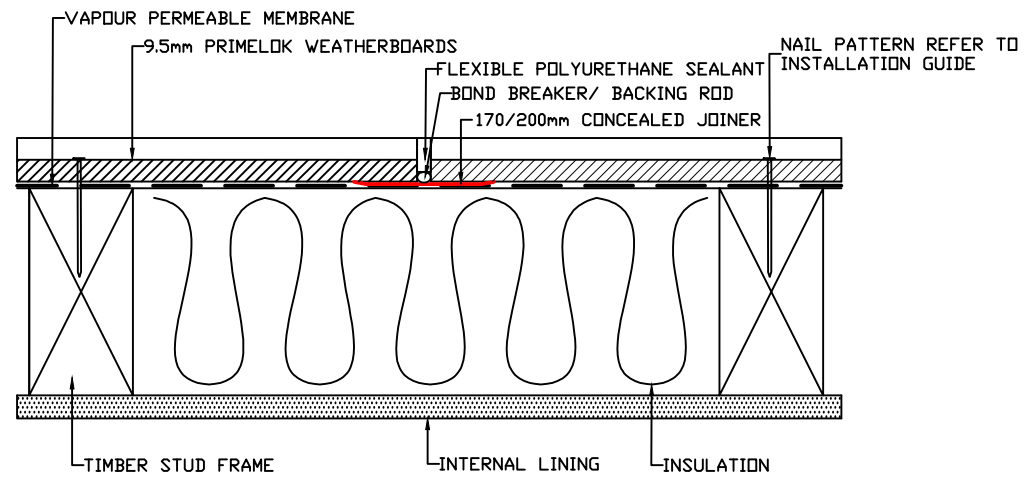

OFF STUD CONCEALED JOINER DETAIL

NOTE: JOINER PROVIDE 6MM GAP

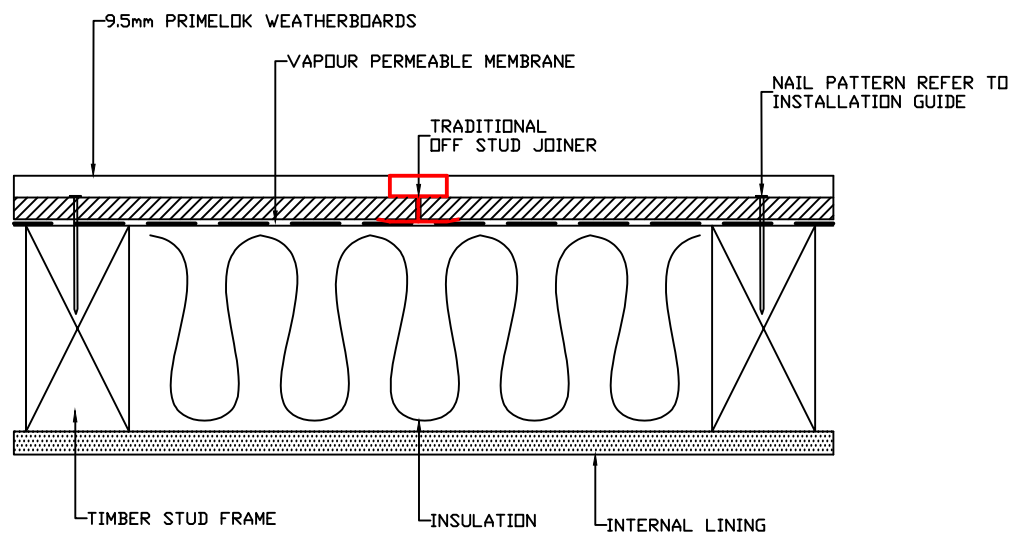

OFF STUD TRADITIONAL JOINER DETAIL

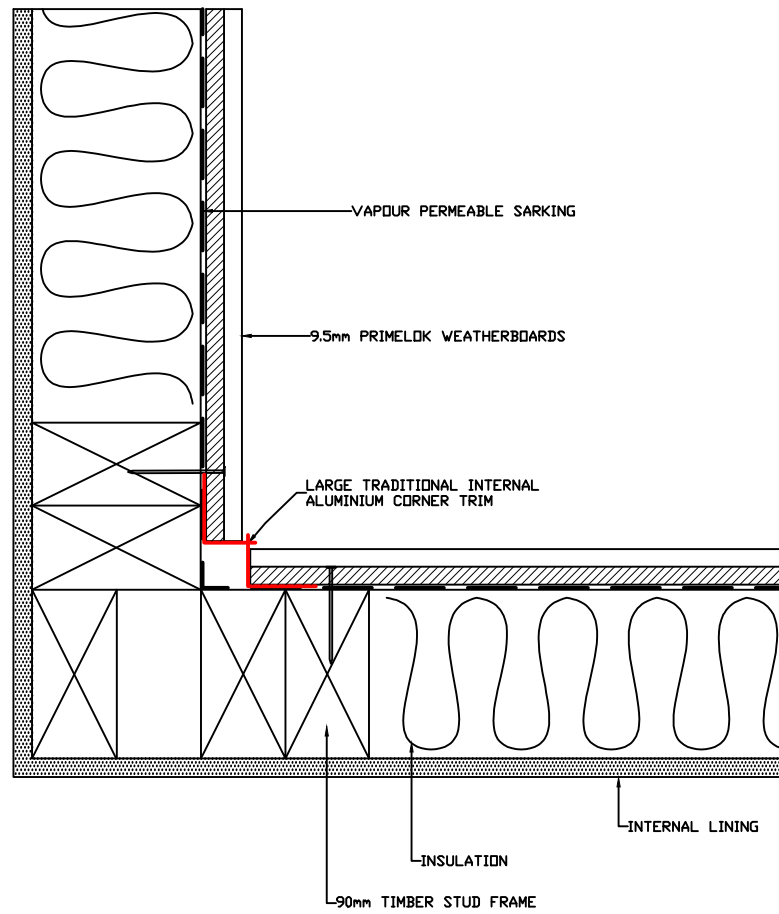

LARGE TRADITIONAL INTERNAL "W" CORNER DETAIL

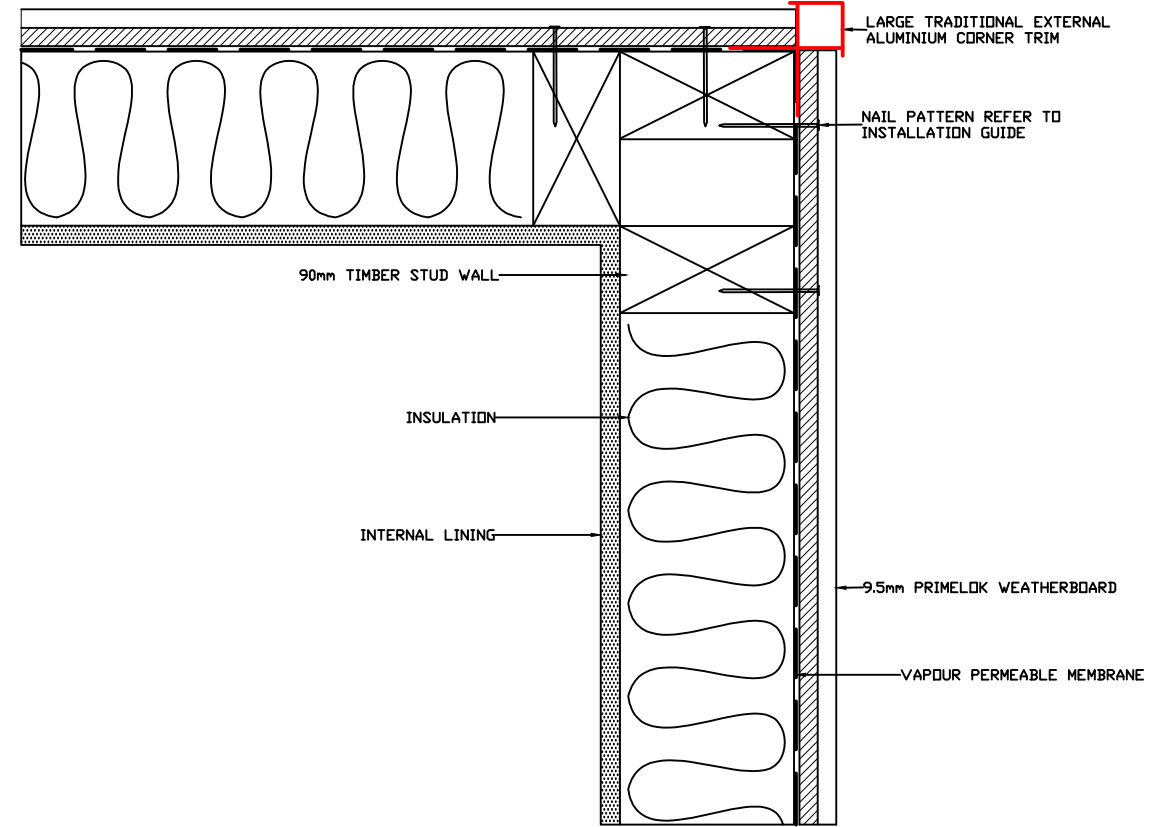

LARGE TRADITIONAL EXTERNAL "BOX" CORNER DETAIL

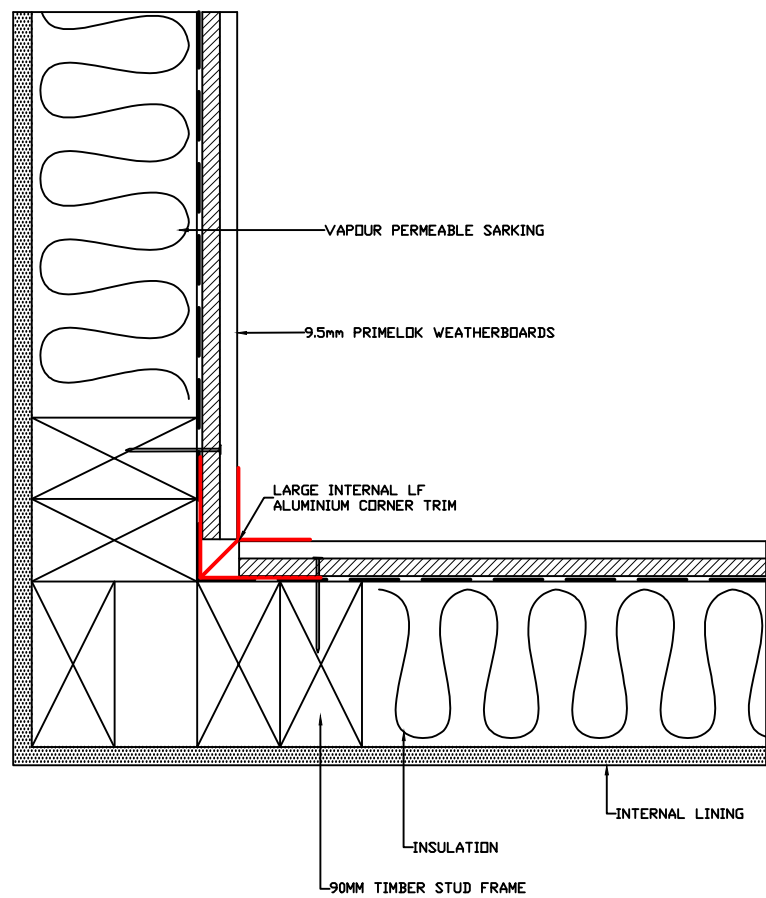

LARGE INTERNAL LF CORNER DETAIL

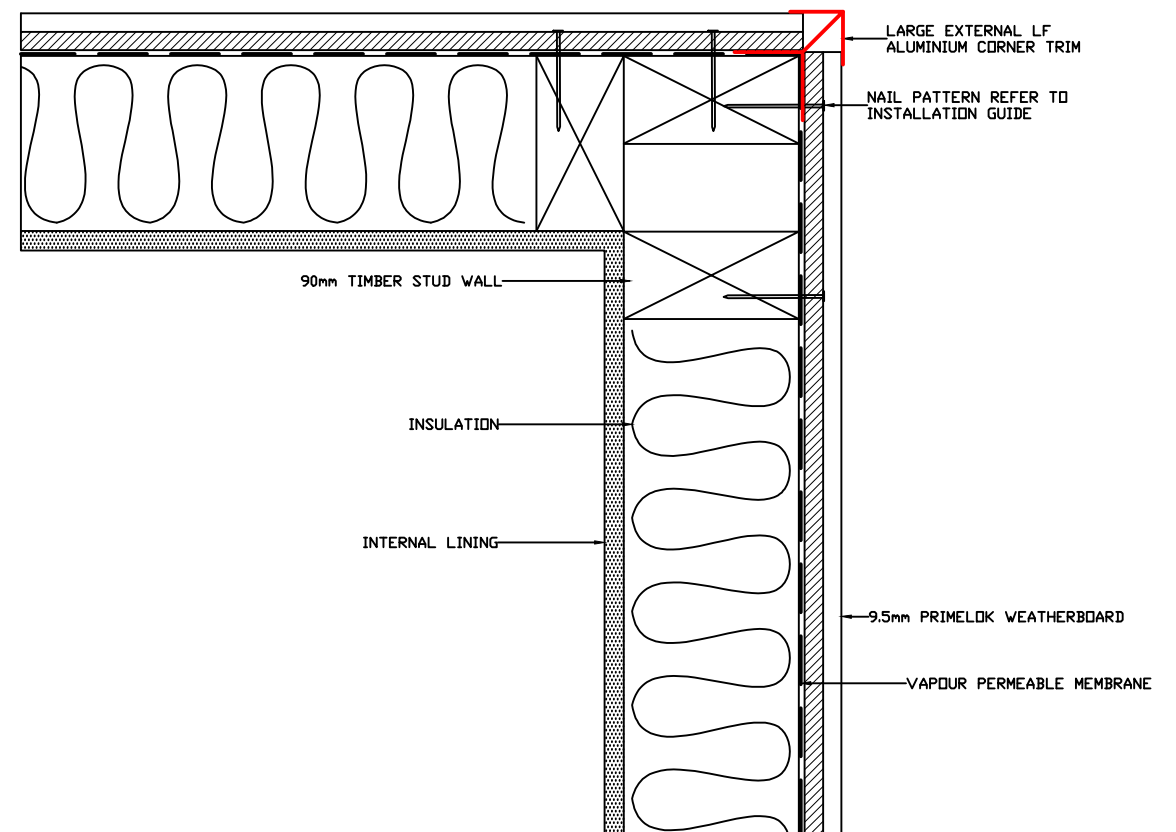

LARGE EXTERNAL LF CORNER DETAIL



DRAWING NAME:  
DIRECT FIX INSTALLATION - PRIMELOK

SCALE:  
NTS

DRAWN BY:  
A.MOATE

CHECKED BY:  
C.O'NEILL

DATE:  
26.10.17

DRAWING SET No.:  
CD-PL-D

SHT SIZE  
A3

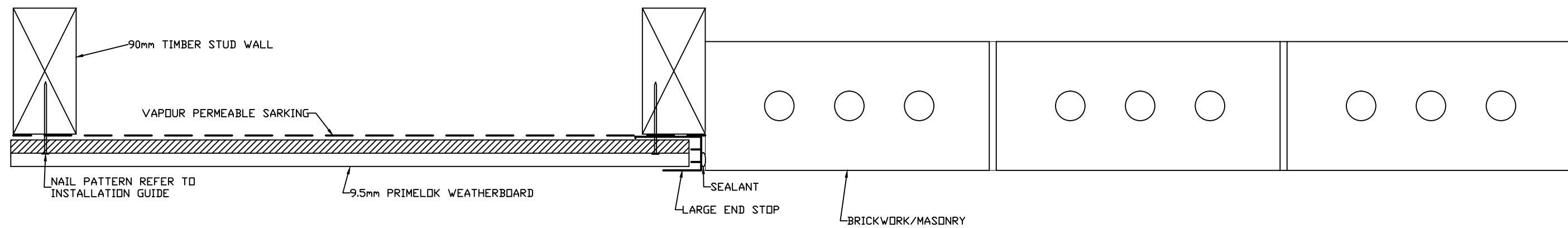

ENDSTOP TO MASONRY DETAIL



DRAWING NAME:	SCALE:	DRAWN BY:	CHECKED BY:	DATE:	DRAWING SET No.:	SHT SIZE
DIRECT FIX INSTALLATION - PRIMELOK	NTS	A.MOATE	C.O'NEILL	26.10.17	CD-PL-D	A3

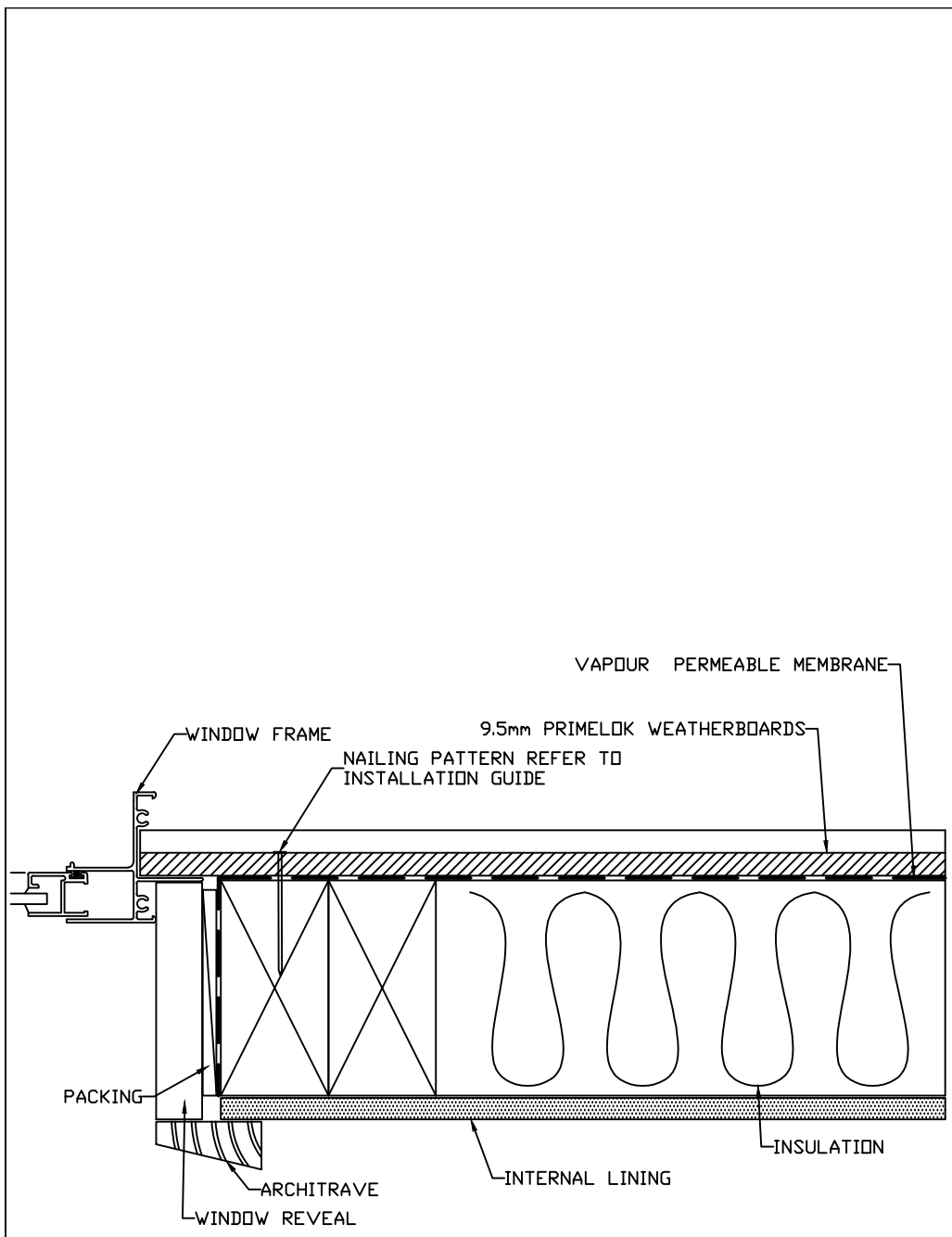

WINDOW JAMB DETAIL

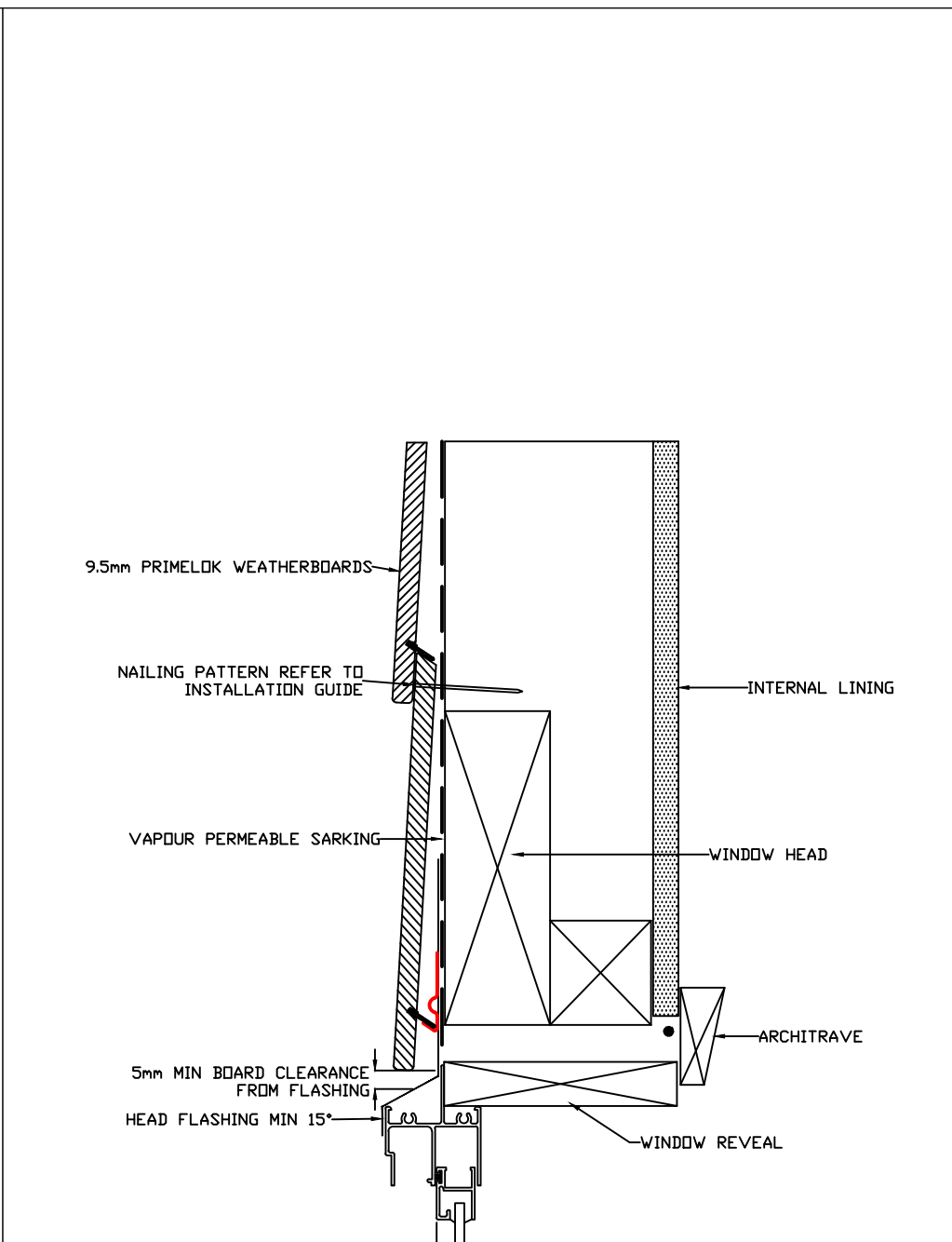

WINDOW HEAD DETAIL

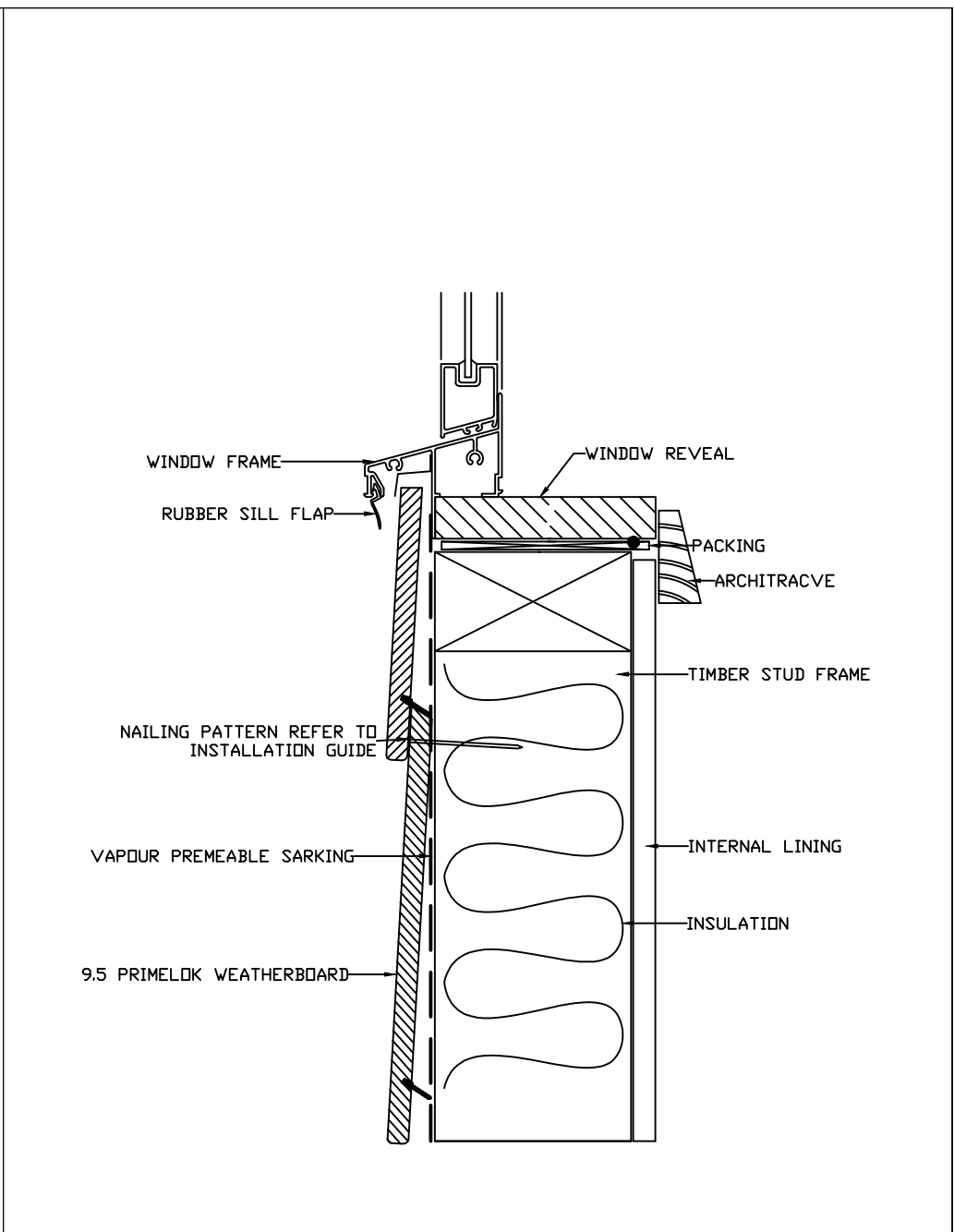

WINDOW SILL DETAIL

	DRAWING NAME: DIRECT FIX INSTALLATION - PRIMELOK	SCALE: NTS	DRAWN BY: A.MOATE	CHECKED BY: C.O'NEILL	DATE: 26.10.17	DRAWING SET No.: CD-PL-D	SHT SIZE A3
--	---	---------------	----------------------	--------------------------	-------------------	-----------------------------	----------------

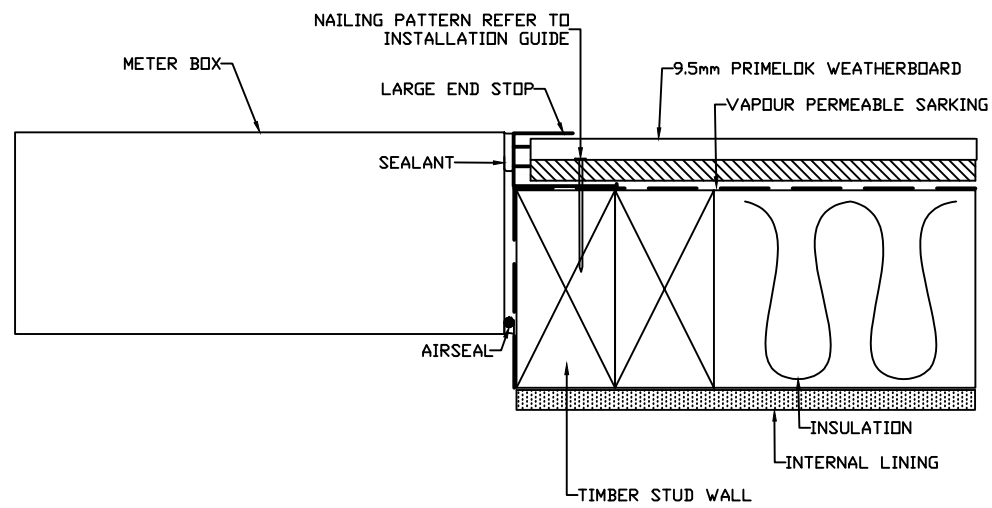

METER BOX JAMB  
DETAIL

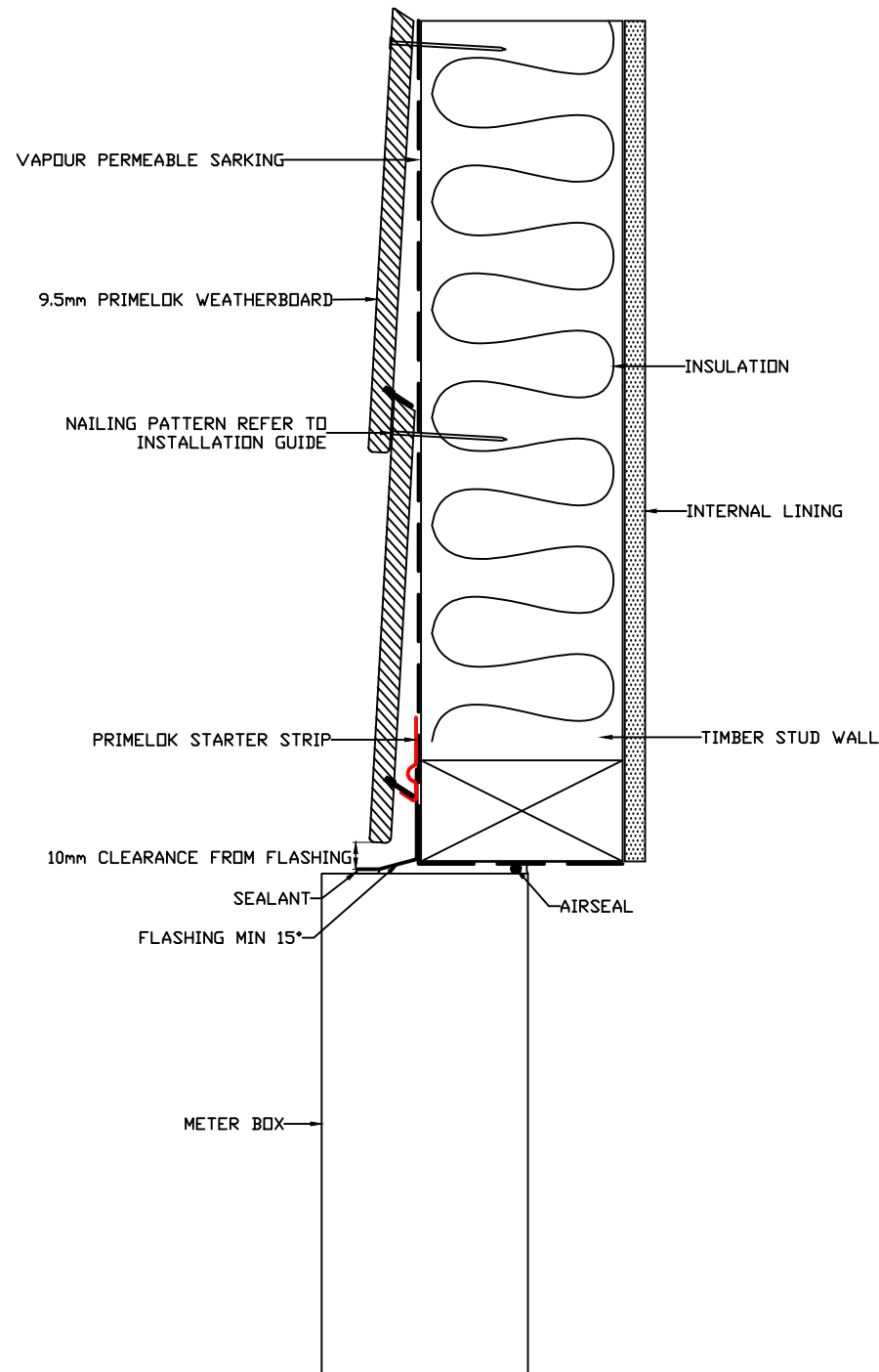

METER BOX HEAD DETAIL

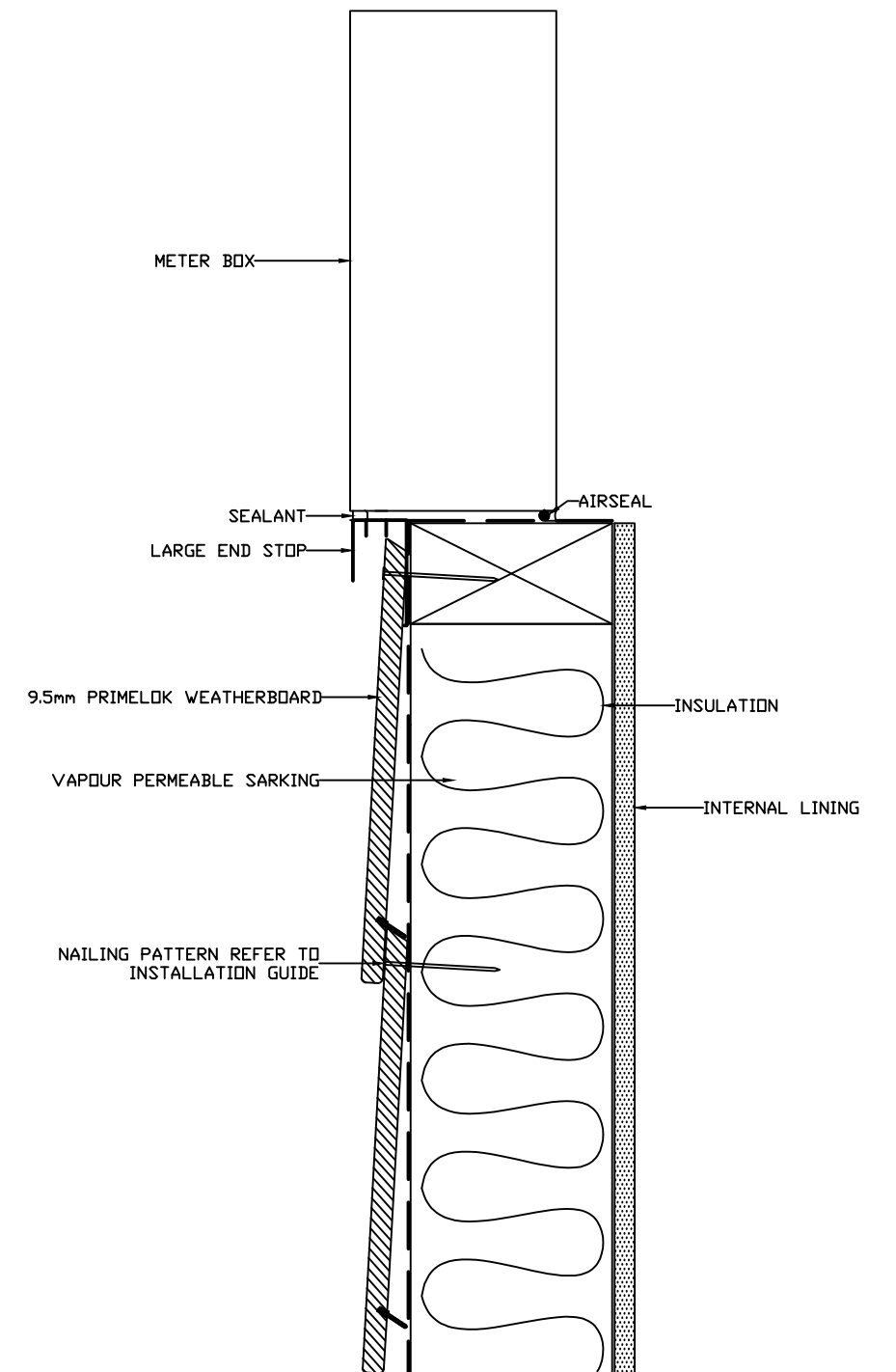

METER BOX SILL DETAIL

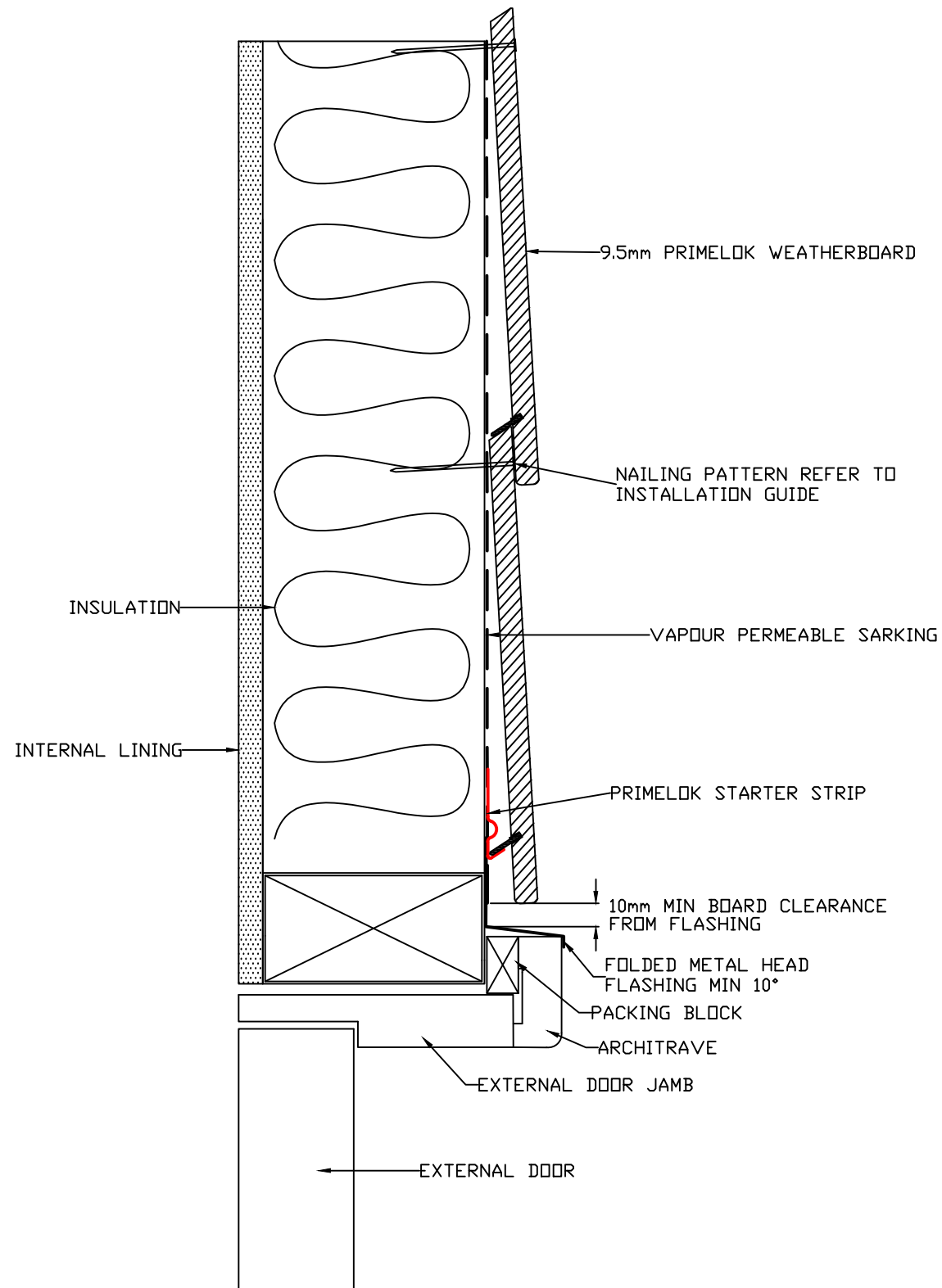

DOOR HEAD DETAIL



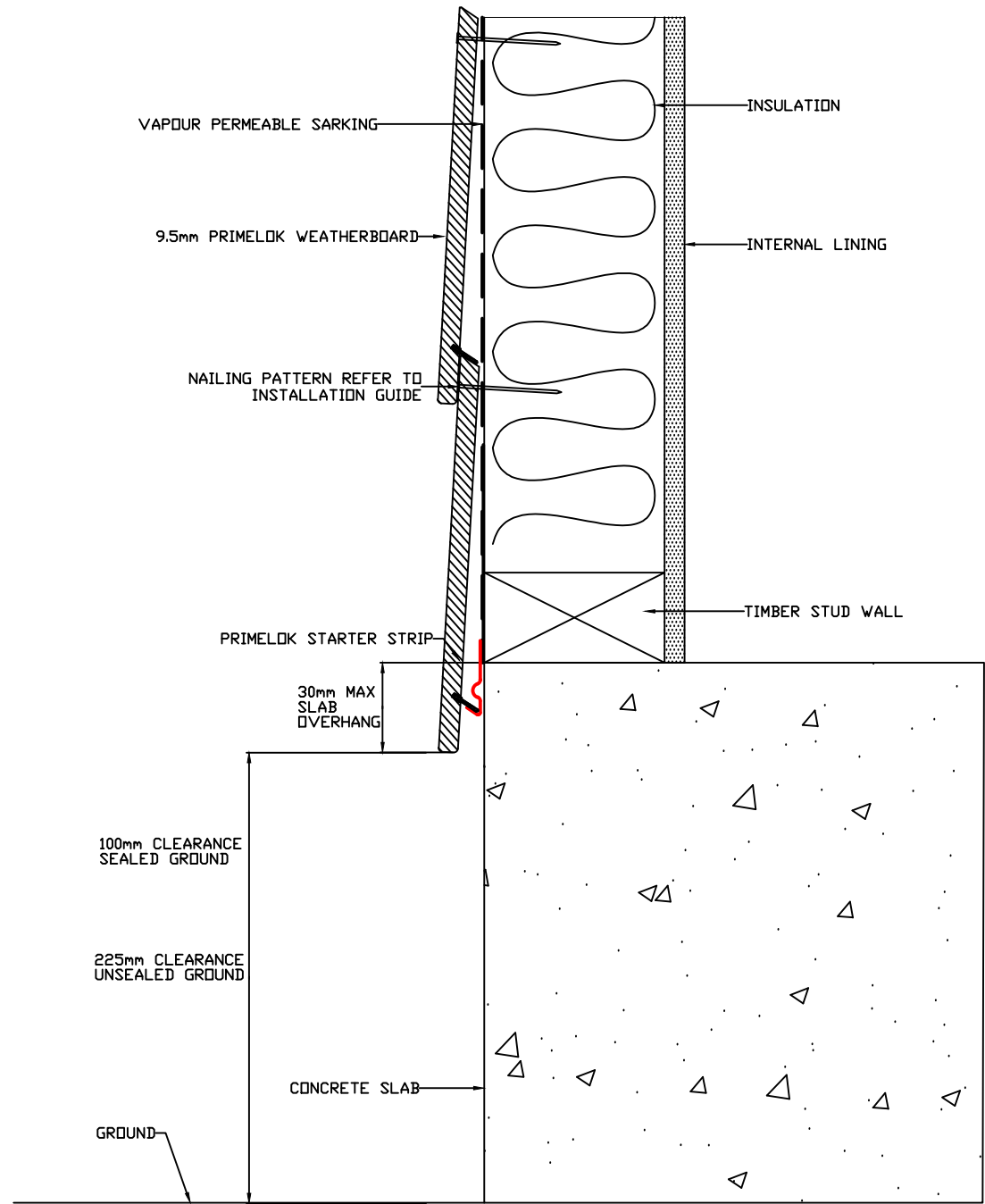

CONCRETE SLAB  
GROUND CLEARANCE DETAIL

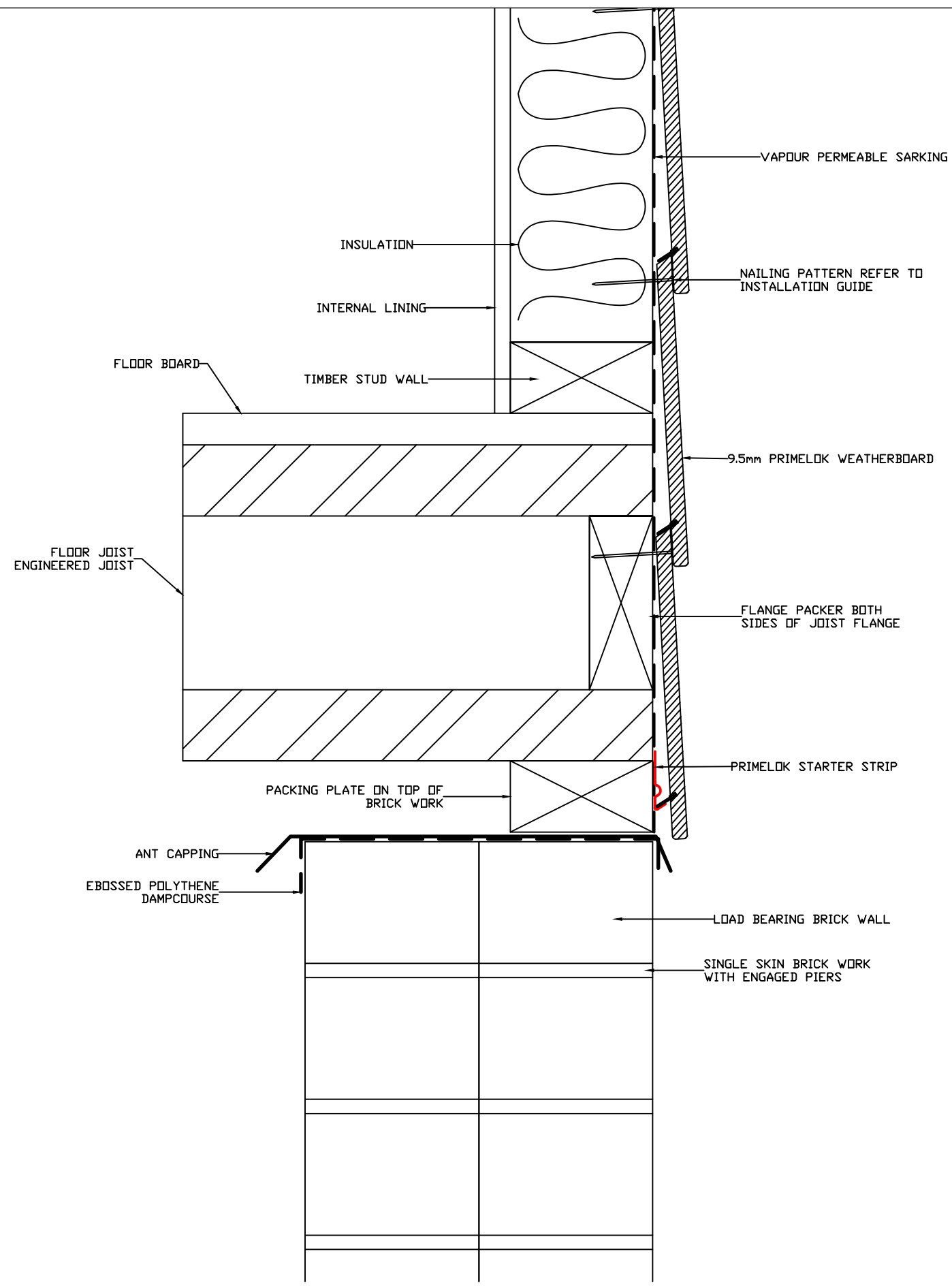

OVER DOUBLE BRICK PIER DETAIL



DRAWING NAME:  
DIRECT FIX INSTALLATION - PRIMELOK

SCALE:  
NTS

DRAWN BY:  
A.MOATE

CHECKED BY:  
C.O'NEILL

DATE:  
26.10.17

DRAWING SET No.:  
CD-PL-D

SHT SIZE  
A3

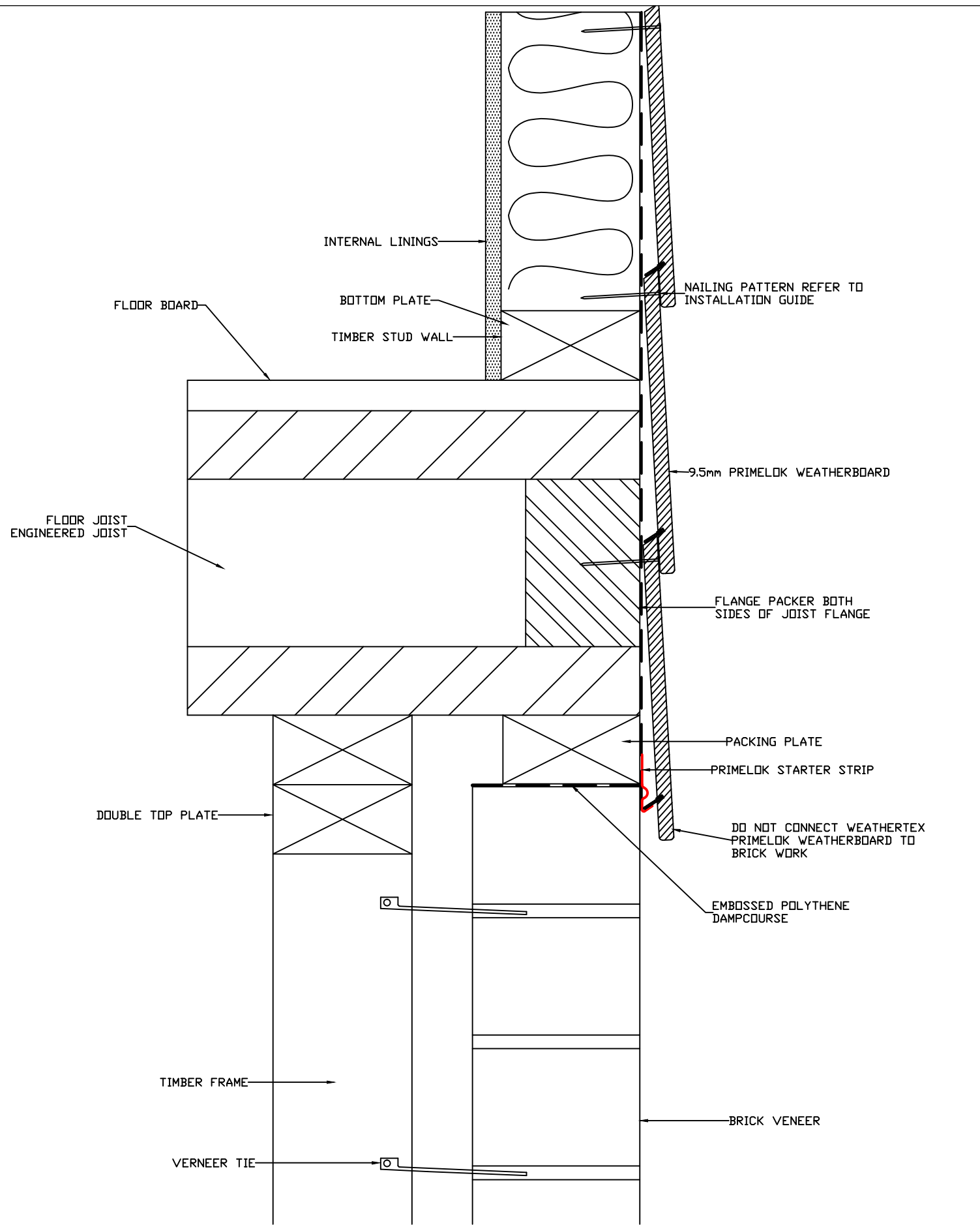

FLUSH WITH BRICK VENEER DETAIL

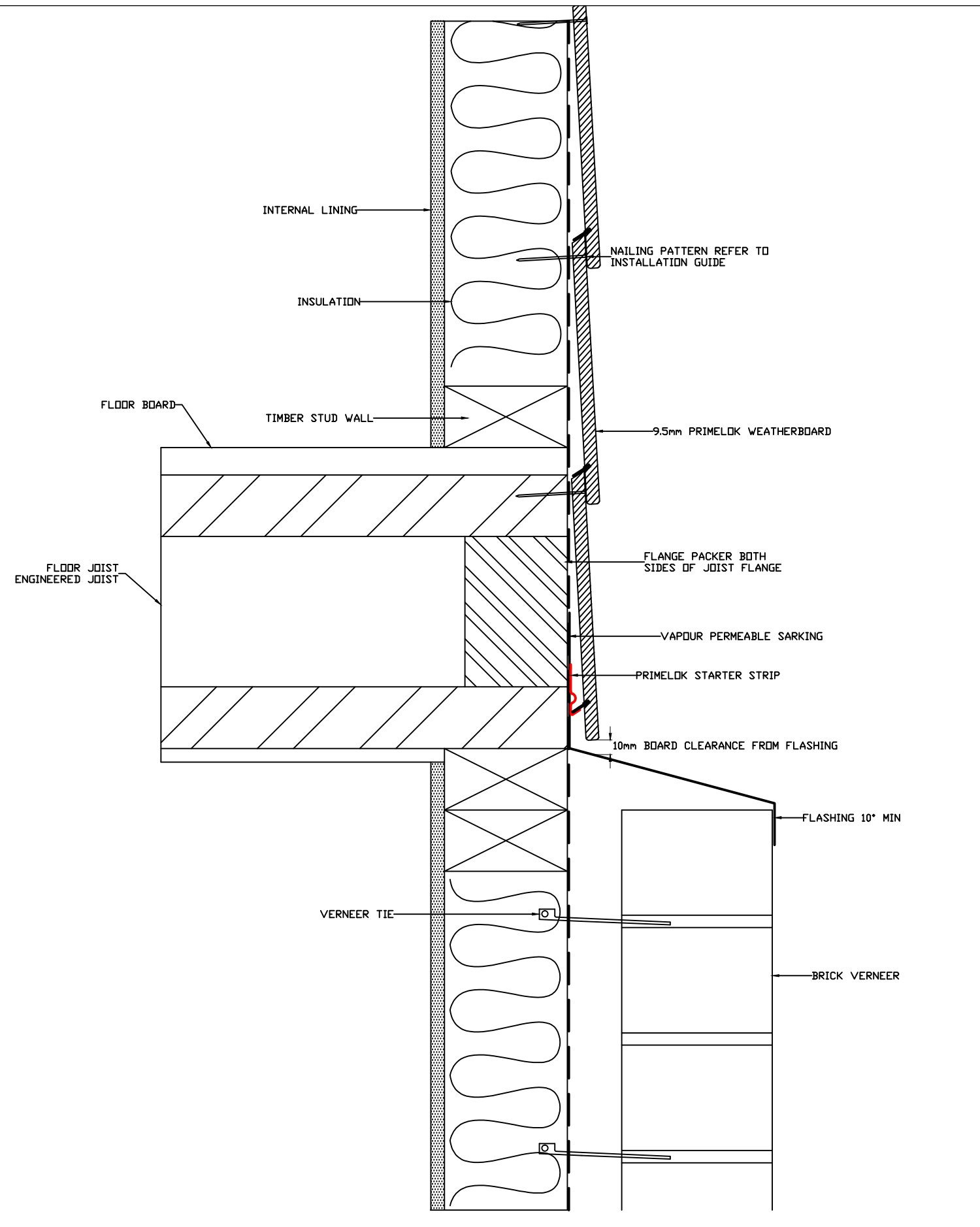

SET BACK OVER BRICK VENEER DETAIL



DRAWING NAME:  
DIRECT FIX INSTALLATION - PRIMELOK

SCALE:  
NTS

DRAWN BY:  
A.MOATE

CHECKED BY:  
C.O'NEILL

DATE:  
26.10.17

DRAWING SET No.:  
CD-PL-D

SHT SIZE  
A3

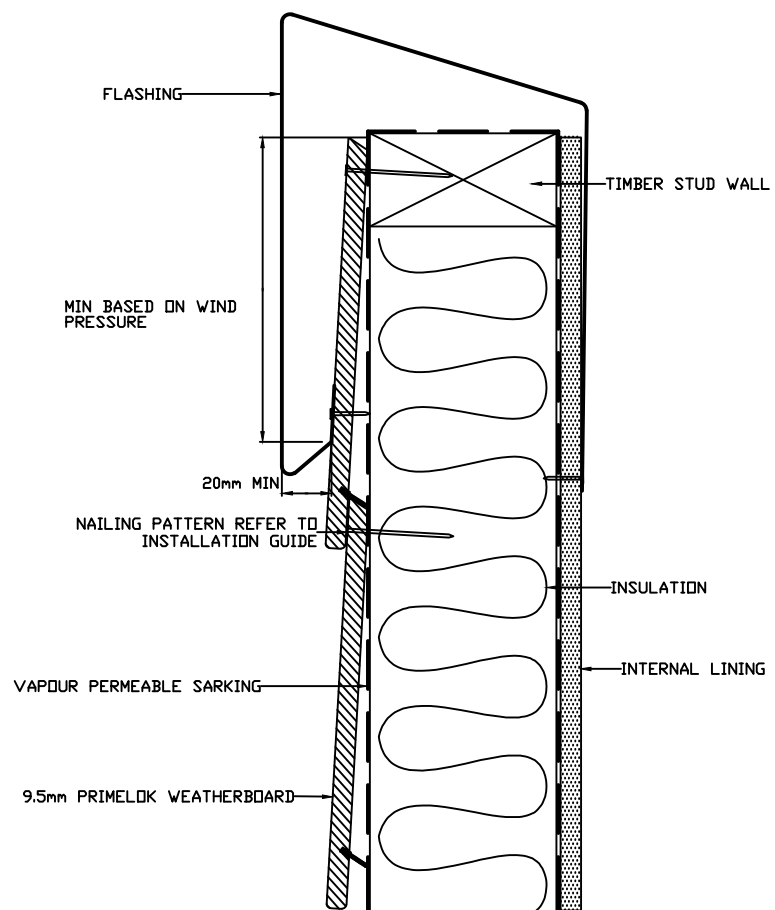

PARAPET DETAIL

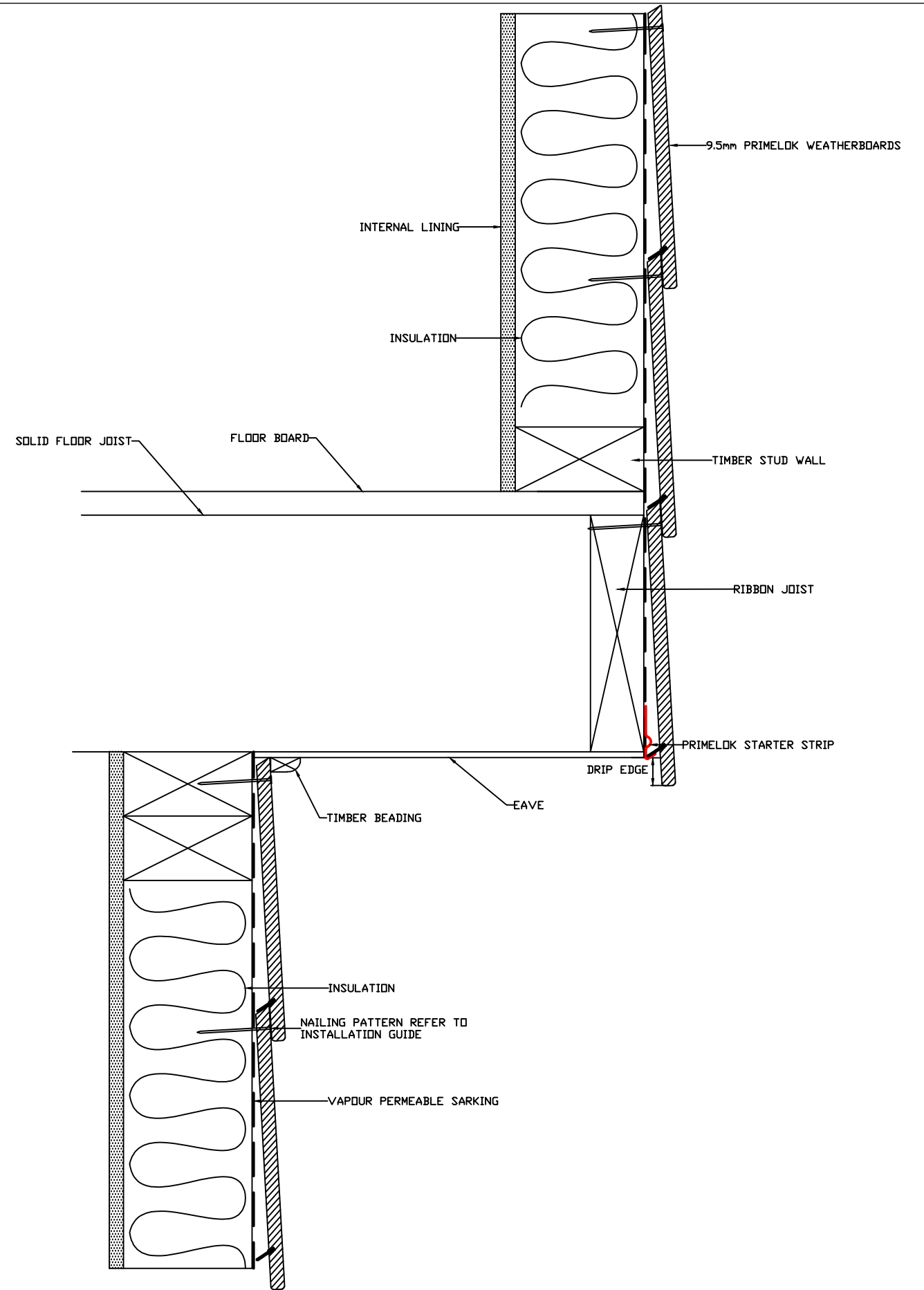

CANTILEVER ROOF DETAIL



DRAWING NAME:  
DIRECT FIX INSTALLATION - PRIMELOK

SCALE:  
NTS

DRAWN BY:  
A.MOATE

CHECKED BY:  
C.O'NEILL

DATE:  
26.10.17

DRAWING SET No.:  
CD-PL-D

SHT SIZE  
A3

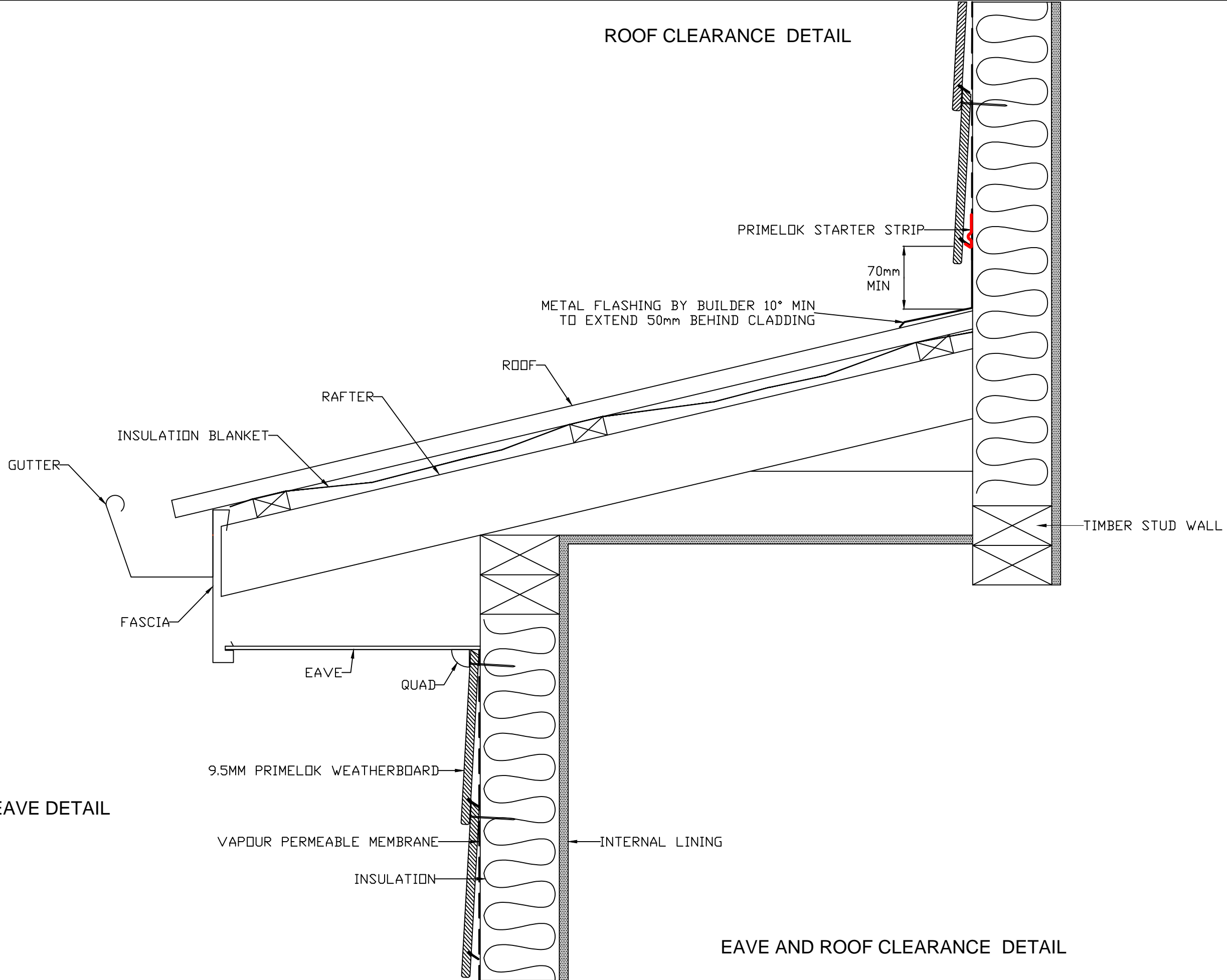

ROOF CLEARANCE DETAIL

EAVE DETAIL

EAVE AND ROOF CLEARANCE DETAIL



DRAWING NAME:	SCALE:	DRAWN BY:	CHECKED BY:	DATE:	DRAWING SET No.:	SHT SIZE
DIRECT FIX INSTALLATION - PRIMELOK	NTS	A.MOATE	C.O'NEILL	26.10.17	CD-PL-D	A3

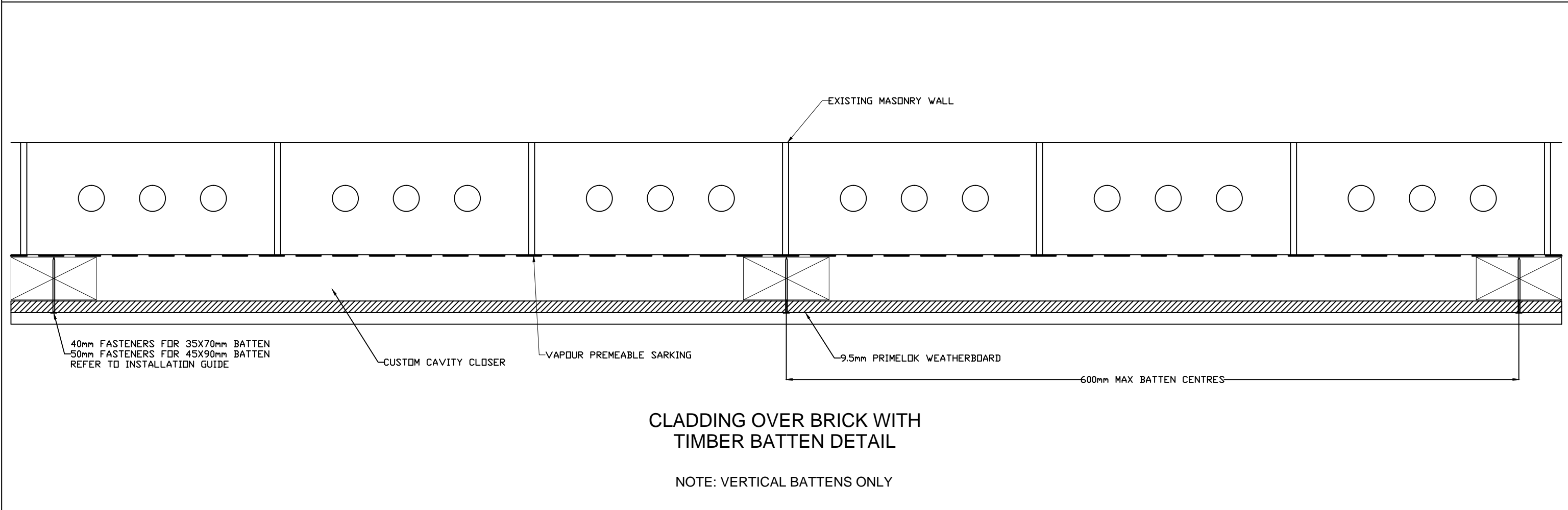
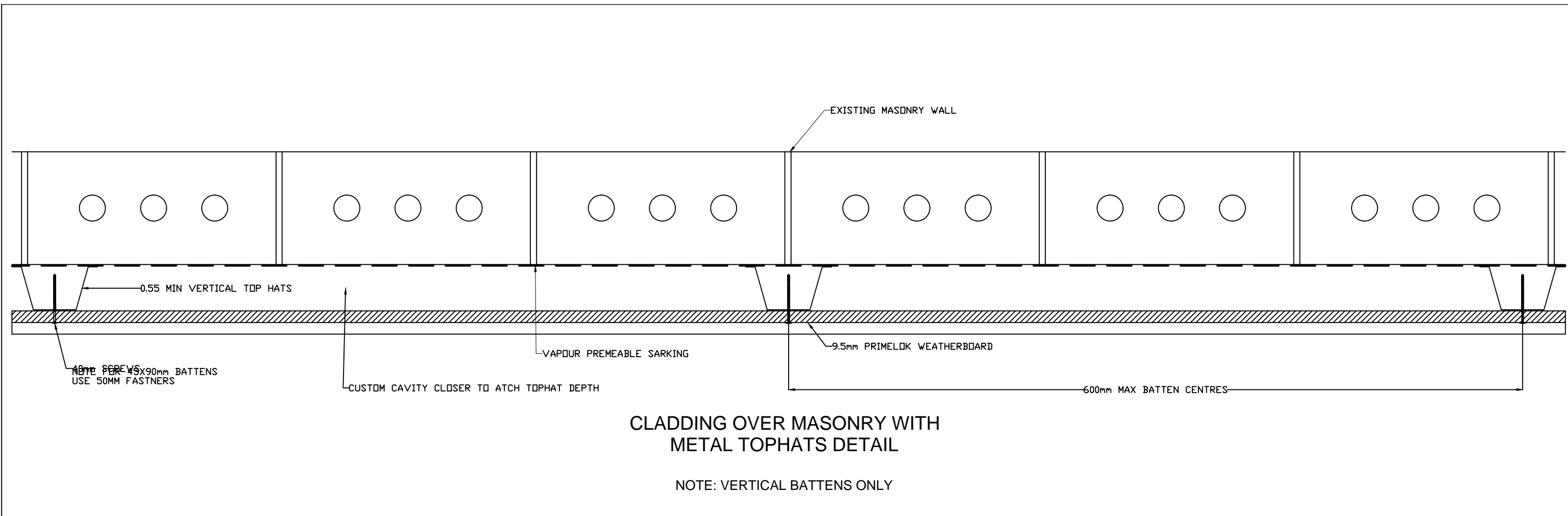

	DRAWING NAME:	SCALE:	DRAWN BY:	CHECKED BY:	DATE:	DRAWING SET No.:	SHT SIZE
	DIRECT FIX INSTALLATION - PRIMELOK	NTS	A.MOATE	C.O'NEILL	26.10.17	CD-PL-D	A3